

# Dell™ Vostro™ 1000 Owner's Manual

**Model PP23LB**

## Notes, Notices, and Cautions



**NOTE:** A NOTE indicates important information that helps you make better use of your computer.



**NOTICE:** A NOTICE indicates either potential damage to hardware or loss of data and tells you how to avoid the problem.



**CAUTION:** A CAUTION indicates a potential for property damage, personal injury, or death.

## Abbreviations and Acronyms

For a complete list of abbreviations and acronyms, see "Glossary" on page 185.

---

**Information in this document is subject to change without notice.**

**© 2007 Dell Inc. All rights reserved.**

Reproduction in any manner whatsoever without the written permission of Dell Inc. is strictly forbidden.

Trademarks used in this text: *Dell*, the *DELL* logo, *Vostro*, and *Strike Zone* are trademarks of Dell Inc.; *Microsoft*, *Outlook*, *Vista*, and *Windows* are registered trademarks of Microsoft Corporation; *AMD*, *Sempron*, *Turion*, and combinations thereof are trademarks of Advanced Micro Devices, Inc.; *ENERGY STAR* is a registered trademark of the U.S. Environmental Protection Agency.

Other trademarks and trade names may be used in this document to refer to either the entities claiming the marks and names or their products. Dell Inc. disclaims any proprietary interest in trademarks and trade names other than its own.

Model PP23LB

October 2007

P/N WY122

Rev. A01

# Contents

1	Finding Information . . . . .	13
2	About Your Computer . . . . .	19
	<b>Determining Your Computer's Configuration</b> . . . . .	19
	<b>Front View</b> . . . . .	20
	<b>Left Side View</b> . . . . .	24
	<b>Right Side View</b> . . . . .	25
	<b>Back View</b> . . . . .	27
	<b>Bottom View</b> . . . . .	29
3	Setting Up Your Computer . . . . .	31
	<b>Connecting to the Internet</b> . . . . .	31
	Setting Up Your Internet Connection . . . . .	31
	<b>Transferring Information to a New Computer</b> . . . . .	33
	Microsoft® Windows® XP . . . . .	33
	Microsoft Windows Vista® . . . . .	36
	<b>Setting Up a Printer</b> . . . . .	37
	Printer Cable . . . . .	37
	Connecting a USB Printer . . . . .	37

<b>Power Protection Devices</b> . . . . .	<b>39</b>
Surge Protectors . . . . .	39
Line Conditioners . . . . .	39
Uninterruptible Power Supplies . . . . .	39
<b>4 Using the Display</b> . . . . .	<b>41</b>
<b>Adjusting Brightness</b> . . . . .	<b>41</b>
<b>Using a Projector</b> . . . . .	<b>41</b>
<b>Making Images and Text Look Bigger or Sharper</b> . . . . .	<b>41</b>
Microsoft® Windows® XP . . . . .	42
Windows Vista® . . . . .	42
<b>Using Both a Monitor and Your Computer Display</b> . . . . .	<b>43</b>
Microsoft® Windows® XP . . . . .	43
Windows Vista® . . . . .	44
<b>Using a Monitor as Your Primary Display</b> . . . . .	<b>44</b>
Microsoft Windows XP . . . . .	44
Windows Vista . . . . .	45
<b>Using Catalyst® Control Center</b> . . . . .	<b>45</b>
Launching Catalyst Control Center . . . . .	46
<b>5 Using the Keyboard and Touch Pad</b> . . . . .	<b>47</b>
<b>Numeric Keypad</b> . . . . .	<b>47</b>
<b>Key Combinations</b> . . . . .	<b>48</b>
System Functions . . . . .	48
Battery . . . . .	48
CD or DVD Tray . . . . .	48
Display Functions . . . . .	48



	Power Management . . . . .	48
	Speaker Functions . . . . .	49
	Microsoft® Windows® Logo Key Functions . . . . .	49
	Adjusting Keyboard Settings . . . . .	49
	<b>Touch Pad . . . . .</b>	<b>50</b>
	Customizing the Touch Pad. . . . .	51
<b>6</b>	<b>Using a Battery . . . . .</b>	<b>53</b>
	<b>Battery Performance. . . . .</b>	<b>53</b>
	<b>Checking the Battery Charge . . . . .</b>	<b>54</b>
	Dell™ QuickSet Battery Meter . . . . .	54
	Microsoft® Windows® Power Meter . . . . .	55
	Charge Gauge . . . . .	55
	Low-Battery Warning. . . . .	56
	<b>Conserving Battery Power. . . . .</b>	<b>56</b>
	Power Management Modes . . . . .	56
	Configuring Power Management Settings . . . . .	58
	Accessing Power Options Properties . . . . .	58
	<b>Charging the Battery. . . . .</b>	<b>58</b>
	<b>Replacing the Battery . . . . .</b>	<b>59</b>
	<b>Storing a Battery. . . . .</b>	<b>60</b>
<b>7</b>	<b>Using Multimedia . . . . .</b>	<b>61</b>
	<b>Playing a CD or DVD. . . . .</b>	<b>61</b>
	<b>Adjusting the Volume . . . . .</b>	<b>62</b>
	<b>Adjusting the Picture . . . . .</b>	<b>62</b>

	<b>Copying CDs and DVDs.</b>	<b>63</b>
	How to Copy a CD or DVD.	63
	Using Blank CDs and DVDs.	64
	Helpful Tips	65
	<b>Adjusting the Volume</b>	<b>66</b>
	<b>Adjusting the Picture.</b>	<b>67</b>
<b>8</b>	<b>Using Cards</b>	<b>69</b>
	<b>ExpressCards.</b>	<b>69</b>
	ExpressCard Blanks.	69
	Installing an ExpressCard.	70
	Removing an ExpressCard or Blank	71
	<b>Media Memory Cards</b>	<b>72</b>
	Installing a Media Memory Card	72
	Removing a Media Memory Card.	73
<b>9</b>	<b>Setting Up and Using Networks</b>	<b>75</b>
	<b>Physically Connecting to a Network or Broadband Modem.</b>	<b>75</b>
	<b>Connecting a Network or Broadband Modem Cable.</b>	<b>75</b>
	Setting Up a Network in the Microsoft® Windows® XP Operating System.	76
	Setting Up a Network in the Microsoft Windows Vista® Operating System.	76
	<b>Wireless Local Area Network (WLAN)</b>	<b>77</b>
	What You Need to Establish a WLAN Connection	77

Checking Your Wireless Network Card . . . . .	77
Setting Up a New WLAN Using a Wireless Router and a Broadband Modem . . . . .	78
Connecting to a WLAN . . . . .	79
Enabling/Disabling the Wireless Network Card . . . . .	81
Mobile Broadband/Wireless Wide Area Network (WWAN) . . . . .	82
What You Need to Establish a Mobile Broadband Network Connection . . . . .	82
Checking Your Dell Mobile Broadband Card . . . . .	83
<b>Microsoft® Windows® Firewall</b> . . . . .	<b>83</b>
<b>10 Securing Your Computer . . . . .</b>	<b>85</b>
<b>Security Cable Lock</b> . . . . .	<b>85</b>
<b>Passwords</b> . . . . .	<b>85</b>
<b>Computer Tracking Software</b> . . . . .	<b>86</b>
<b>If Your Computer Is Lost or Stolen</b> . . . . .	<b>86</b>
<b>11 Adding and Replacing Parts . . . . .</b>	<b>89</b>
<b>Before You Begin</b> . . . . .	<b>89</b>
Recommended Tools . . . . .	89
Turning Off Your Computer . . . . .	89
Before Working Inside Your Computer . . . . .	90
<b>Optical Drive</b> . . . . .	<b>92</b>
<b>Hard Drive</b> . . . . .	<b>92</b>
Returning a Hard Drive to Dell . . . . .	94

<b>Memory</b> . . . . .	<b>95</b>
<b>Modem</b> . . . . .	<b>98</b>
<b>Hinge Cover</b> . . . . .	<b>100</b>
<b>Keyboard</b> . . . . .	<b>101</b>
<b>Wireless Mini-Card</b> . . . . .	<b>103</b>
<b>Coin-Cell Battery</b> . . . . .	<b>106</b>
<b>Display</b> . . . . .	<b>107</b>
<b>12 Troubleshooting</b> . . . . .	<b>111</b>
<b>Dell Technical Update Service</b> . . . . .	<b>111</b>
<b>Dell Diagnostics</b> . . . . .	<b>111</b>
<b>Dell Support Center</b> . . . . .	<b>116</b>
Dell Support . . . . .	116
Dell PC TuneUp . . . . .	117
Dell PC Checkup . . . . .	118
Dell Network Assistant . . . . .	118
DellConnect . . . . .	118
<b>Drive Problems</b> . . . . .	<b>119</b>
Optical drive problems . . . . .	119
Hard drive problems . . . . .	120
<b>E-Mail, Modem, and Internet Problems</b> . . . . .	<b>121</b>
<b>Error Messages</b> . . . . .	<b>123</b>
<b>ExpressCard Problems</b> . . . . .	<b>128</b>
<b>IEEE 1394 Device Problems</b> . . . . .	<b>128</b>

<b>Keyboard Problems</b> . . . . .	<b>129</b>
External Keyboard problems . . . . .	129
Unexpected characters . . . . .	130
<b>Lockups and Software Problems</b> . . . . .	<b>130</b>
The computer does not start . . . . .	130
The computer stops responding . . . . .	131
A program stops responding or crashes repeatedly . . . . .	131
A program is designed for an earlier Microsoft® Windows® operating system . . . . .	131
A solid blue screen appears . . . . .	132
Dell MediaDirect problems . . . . .	132
Other software problems . . . . .	133
<b>Memory Problems</b> . . . . .	<b>133</b>
<b>Network Problems</b> . . . . .	<b>134</b>
Mobile Broadband (Wireless Wide Area Network [WWAN]) . . . . .	135
<b>Power Problems</b> . . . . .	<b>135</b>
<b>Printer Problems</b> . . . . .	<b>137</b>
<b>Scanner Problems</b> . . . . .	<b>138</b>
<b>Sound and Speaker Problems</b> . . . . .	<b>138</b>
No sound from integrated speakers . . . . .	139
No sound from external speakers . . . . .	139
No sound from headphones . . . . .	139
<b>Remote Control Problems</b> . . . . .	<b>140</b>
<b>Touch Pad or Mouse Problems</b> . . . . .	<b>140</b>

<b>Video and Display Problems</b> . . . . .	<b>141</b>
If the display is blank . . . . .	141
If the display is difficult to read . . . . .	142
If only part of the display is readable . . . . .	143
<b>Drivers</b> . . . . .	<b>143</b>
What Is a Driver? . . . . .	143
Identifying Drivers . . . . .	143
Reinstalling Drivers and Utilities . . . . .	144
<b>Troubleshooting Software and Hardware Problems</b> . . . . .	<b>147</b>
<b>Restoring Your Microsoft® Windows Vista® Operating System</b> . . . . .	<b>148</b>
Using Windows Vista System Restore . . . . .	149
Restoring the Computer to the Default Factory Configuration . . . . .	151
Using the Operating System Media . . . . .	152
<b>Restoring Your Microsoft® Windows® XP Operating System</b> . . . . .	<b>153</b>
Using Microsoft Windows System Restore . . . . .	154
Using Dell™ PC Restore . . . . .	155
Using the Operating System Media . . . . .	157
<b>13 Dell™ QuickSet Features</b> . . . . .	<b>159</b>
<b>14 Traveling With Your Computer</b> . . . . .	<b>161</b>
<b>Identifying Your Computer</b> . . . . .	<b>161</b>
<b>Packing the Computer</b> . . . . .	<b>161</b>

<b>Travel Tips</b> . . . . .	<b>162</b>
Traveling by Air . . . . .	163
15 Contacting Dell . . . . .	165
16 Specifications . . . . .	167
17 Appendix . . . . .	175
<b>Using the System Setup Program</b> . . . . .	<b>175</b>
Viewing the System Setup Screens . . . . .	176
Commonly Used Options . . . . .	177
<b>Cleaning Your Computer</b> . . . . .	<b>179</b>
Computer, Keyboard, and Display . . . . .	179
Touch Pad . . . . .	180
Mouse . . . . .	180
Floppy Drive . . . . .	181
CDs and DVDs . . . . .	181
<b>FCC Notice (U.S. Only)</b> . . . . .	<b>182</b>
FCC Class B . . . . .	182
<b>Macrovision Product Notice</b> . . . . .	<b>183</b>
Glossary . . . . .	185
Index . . . . .	203





# Finding Information

 **NOTE:** Some features or media may be optional and may not ship with your computer. Some features or media may not be available in certain countries.

 **NOTE:** Additional information may ship with your computer.

## What Are You Looking For?

- A diagnostic program for my computer
- Drivers for my computer
- My computer documentation
- My device documentation
- Notebook System Software (NSS)

## Find It Here

### Drivers and Utilities Media

Documentation and drivers are already installed on your computer. You can use the media to reinstall drivers (see "Reinstalling Drivers and Utilities" on page 144). To run the Dell Diagnostics, see "Dell Diagnostics" on page 111.

Readme files may be included on your media to provide last-minute updates about technical changes to your computer or advanced technical-reference material for technicians or experienced users.



**NOTE:** Drivers and documentation updates can be found at [support.dell.com](http://support.dell.com).

---

**What Are You Looking For?**

- Warranty information
- Terms and Conditions (U.S. only)
- Safety instructions
- Regulatory information
- Ergonomics information
- End User License Agreement

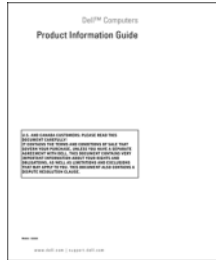
**Find It Here****Dell™ Product Information Guide**

- 
- How to set up my computer

**Setup Diagram**

**NOTE:** See the setup diagram that came with your computer.

---

**What Are You Looking For?**

- Service Tag and Express Service Code
- Microsoft Windows License Label

**Find It Here****Service Tag and Microsoft® Windows® License**

**NOTE:** Your computer's Service Tag and Microsoft® Windows® License labels are located on your computer.

Your computer's Service Tag contains both a Service Tag number and an Express Service Code.

- Use the Service Tag to identify your computer when you use [support.dell.com](http://support.dell.com) or contact support.
- Enter the Express Service Code to direct your call when contacting support.



- Use the product key on the License Label if you need to reinstall your operating system.

**NOTE:** As an increased security measure, the newly designed Microsoft Windows license label incorporates a missing portion or "hole" to discourage removal of the label.

---

**What Are You Looking For?****Find It Here**

- Solutions — Troubleshooting hints and tips; articles from technicians; online courses; and frequently asked questions
- Community — Online discussion with other Dell customers
- Upgrades — Upgrade information for components, such as memory, the hard drive, and the operating system
- Customer Care — Contact information, service call and order status, warranty, and repair information
- Service and support — Service call status and support history, service contract, online discussions with technical support
- Reference — Computer documentation, details on my computer configuration, product specifications, and white papers
- Downloads — Certified drivers, patches, and software updates
- How to find information about my computer and its components
- How to connect to the Internet
- How to add user accounts for different people
- How to transfer files and settings from another computer

**Dell Support Website — [support.dell.com](http://support.dell.com)**

**NOTE:** Select your region or business segment to view the appropriate support site.

**Windows Welcome Center (Microsoft Windows Vista®)**

The Windows Welcome Center automatically appears when you use the computer for the first time. You can choose to have it appear every time you start your computer by placing a check in the **Run at startup** checkbox. Another method of accessing the Welcome Center is to click the Windows Vista Start button , and then click **Welcome Center**.

---

**What Are You Looking For?****Find It Here**

---

- Notebook System Software (NSS)— If you reinstall the operating system for your computer, you should also reinstall the NSS utility. NSS provides critical updates for your operating system and support for processors, optical drives, USB devices, and so on. NSS is necessary for correct operation of your Dell computer. The software automatically detects your computer and operating system and installs the updates appropriate for your configuration.

To download Notebook System Software:

- 1** Go to [support.dell.com](http://support.dell.com) and click Drivers & Downloads.
- 2** Enter your Service Tag or Product Type and Product Model, and click **Go**.
- 3** Scroll to **System and Configuration Utilities**→ **Dell Notebook System Software** and click **Download Now**.
- 4** Select **Drivers & Downloads** and click **Go**.

**NOTE:** The [support.dell.com](http://support.dell.com) user interface may vary depending on your selections.

---

- How to use the Windows operating system
- How to work with programs and files
- How to personalize my desktop

**Windows Help and Support Center**

*Microsoft Windows XP:*

- 1** Click the **Start** button and click **Help and Support**.
- 2** Either select one of the topics listed, or type a word or phrase that describes your problem into the **Search** box, click the arrow icon, and then click the topic that describes your problem.
- 3** Follow the instructions on the screen.

*Microsoft Windows Vista:*

- 1** Click the Windows Vista Start button , and then click **Help and Support**.
- 2** In *Search Help*, type a word or phrase that describes your problem, and then press <Enter> or click the magnifying glass.
- 3** Click the topic that describes your problem.
- 4** Follow the instructions on the screen.

---

**What Are You Looking For?**

- How to reinstall my operating system

**Find It Here****Operating System Media**

The operating system is already installed on your computer. To reinstall your operating system, use one of the following methods:

- *Microsoft Windows System Restore* — *Microsoft Windows System Restore* returns your computer to an earlier operating state without affecting data files.
- *Dell PC Restore* — *Dell PC Restore* returns your computer to its original operating state. *Dell PC Restore* may not ship with your computer.
- *Operating System media* — If you received an *Operating System media* with your computer, you can use it to restore your operating system.

For more information, see "Restoring Your Microsoft® Windows Vista® Operating System" on page 148 or "Restoring Your Microsoft® Windows® XP Operating System" on page 153.

After you reinstall your operating system, use the *Drivers and Utilities media* (see "Drivers" on page 143) to reinstall drivers for the devices that came with your computer.



# About Your Computer

## Determining Your Computer's Configuration

Based on selections that you made when purchasing your computer, your computer has one of several different video controller configurations. To determine your computer's video controller configuration:

- 1 Access the Microsoft® Windows® Help and Support Center. For instructions, see "Windows Help and Support Center" on page 17.
- 2 Under **Pick a Task**, click **Use Tools to view your computer information and diagnose problems**.
- 3 Under **My Computer Information**, select **Hardware**.

From the **My Computer Information - Hardware** screen, you can view the type of video controller installed in your computer, as well as the other hardware components.

# Front View



- |    |                                     |   |                      |   |           |
|----|-------------------------------------|---|----------------------|---|-----------|
| 1  | display latch release               | 2 | display latches (2)  | 3 | display   |
| 4  | power button                        | 5 | device status lights | 6 | touch pad |
| 7  | speakers (2)                        | 8 | touch pad buttons    | 9 | keyboard  |
| 10 | keyboard and wireless status lights |   |                      |   |           |



**DISPLAY LATCH RELEASE** — Press to release the display latches and open the display.

**DISPLAY LATCHES** — Keep the display closed.

**DISPLAY** — For more information about your display, see "Using the Display" on page 41.

**POWER BUTTON** — Press the power button to turn on the computer or to enter or exit a power management mode. See "Power Management Modes" on page 56.

#### DEVICE STATUS LIGHTS

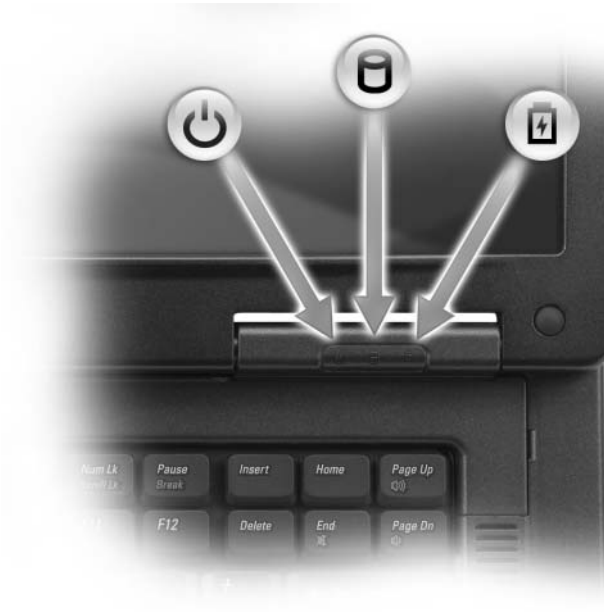

Turns on when you turn on the computer, and blinks when the computer is in a power management mode.



Turns on when the computer reads or writes data.



**NOTICE:** To avoid loss of data, never turn off the computer while the  light is flashing.



Turns on steadily or blinks to indicate battery charge status.

---

If the computer is connected to an electrical outlet, the  light operates as follows:

- Solid green: The battery is charging.
- Flashing green: The battery is almost fully charged.

If the computer is running on a battery, the  light operates as follows:

- Off: The battery is adequately charged (or the computer is turned off).
- Flashing orange: The battery charge is low.
- Solid orange: The battery charge is critically low.

**TOUCH PAD** — Provides the functionality of a mouse. Silk screening on the touch pad indicates scrolling capabilities.



**SPEAKERS** — To adjust the volume of the integrated speakers, press the media control buttons or speaker-volume keyboard shortcuts. For more information, see "Speaker Functions" on page 49.





**TOUCH PAD BUTTONS** — Touch pad buttons provide the functionality of a mouse.

**KEYBOARD** — The keyboard includes a numeric keypad as well as the Microsoft Windows logo key. For information on supported keyboard shortcuts, see "Key Combinations" on page 48.

## KEYBOARD AND WIRELESS STATUS LIGHTS



The green lights located above the keyboard indicate the following:

	Turns on when the numeric keypad is enabled.
	Turns on when the uppercase letter function is enabled.
	Turns on when the scroll lock function is enabled.
	Turns on when wireless networking is enabled. To enable or disable wireless networking, press <Fn><F2>.

## Left Side View

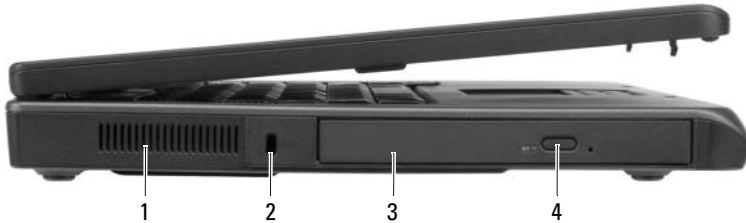

- 1 air vent
- 2 security cable slot
- 3 optical drive bay
- 4 optical-drive-tray eject button

**⚠ CAUTION:** Do not block, push objects into, or allow dust to accumulate in the air vents. Do not store your computer in a low-airflow environment, such as a closed briefcase, while it is running. Restricting the airflow can damage the computer or cause a fire.

**AIR VENT** — The computer uses fans to create airflow through the vents, which prevents the computer from overheating.

**➡ NOTICE:** Before you buy an antitheft device, ensure that it will work with the security cable slot.

**SECURITY CABLE SLOT** — Lets you attach a commercially available antitheft device to the computer. For more information, see the instructions included with the device.



**OPTICAL DRIVE BAY** — You can install devices such as a DVD drive or other optical drive in the optical drive bay. For more information, see "Optical Drive" on page 92.

**OPTICAL-DRIVE-TRAY EJECT BUTTON** — Press this button to eject a CD or DVD from the optical drive.

## Right Side View

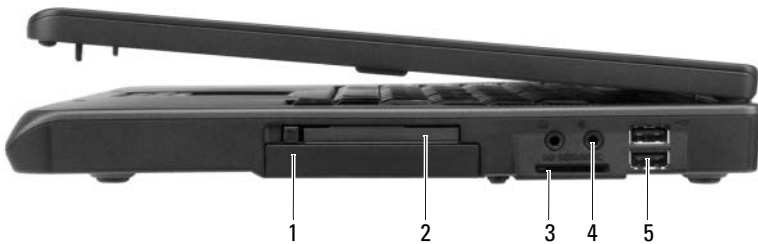

- |   |                      |   |                    |   |                                 |
|---|----------------------|---|--------------------|---|---------------------------------|
| 1 | hard drive           | 2 | ExpressCard slot   | 3 | 3-in-1 media memory card reader |
| 4 | audio connectors (2) | 5 | USB connectors (2) |   |                                 |

**HARD DRIVE** — Stores software and data. For more information, see "Hard Drive" on page 92 and "Hard drive problems" on page 120.

**EXPRESSCARD SLOT** — Supports one ExpressCard. The computer ships with a plastic blank installed in the slot. You can add an ExpressCard to make WWAN connectivity available on your computer. For more information, see "Using Cards" on page 69.

**3-IN-1 MEDIA MEMORY CARD READER** — Provides a fast and convenient way to view and share digital photos, music, and videos stored on a media memory card. The 3-in-1 media memory card reader reads Secure Digital (SD) card/SDIO and MultiMediaCard (MMC) digital media memory cards.

**AUDIO CONNECTORS** —



---

Attach headphones or speakers to the  connector.

---

Attach a microphone to the  connector.

---

**USB CONNECTORS**



---

Connect USB devices, such as a mouse, keyboard, or printer. You can also connect the optional floppy drive directly to a USB connector using the optional floppy-drive cable.

---

## Back View



- |   |                      |   |                           |   |                         |
|---|----------------------|---|---------------------------|---|-------------------------|
| 1 | AC adapter connector | 2 | network connector (RJ-45) | 3 | modem connector (RJ-11) |
| 4 | USB connectors (2)   | 5 | video connector           |   |                         |

**AC ADAPTER CONNECTOR** — Attaches an AC adapter to the computer. The AC adapter converts AC power to the DC power required by the computer. You can connect the AC adapter with your computer turned either on or off.



**⚠ CAUTION:** The AC adapter works with electrical outlets worldwide. However, power connectors and power strips vary among countries. Using an incompatible cable or improperly connecting the cable to the power strip or electrical outlet may cause fire or equipment damage.

**➡ NOTICE:** When you disconnect the AC adapter cable from the computer, grasp the connector, not the cable itself, and pull firmly but gently to help prevent damage to the cable.

## NETWORK CONNECTOR (RJ-45)



Connects the computer to a network. The green and yellow lights next to the connector indicate activity for wired network communications.

For information on using the network adapter, see the online network adapter documentation supplied with your computer.

---

## MODEM CONNECTOR (RJ-11)



To use the internal modem, connect the telephone line to the modem connector.

For additional information on using the modem, see the online modem documentation supplied with your computer.

---



**NOTICE:** The network connector is slightly larger than the modem connector. To help prevent damage to the computer, do not plug a telephone line into the network connector.

## USB CONNECTORS



Connect USB devices, such as a mouse, keyboard, or printer. You can also connect the optional floppy drive directly to a USB connector using the optional floppy-drive cable.

---

## VIDEO CONNECTOR



Connects an external VGA-compatible monitor.

---



## Bottom View

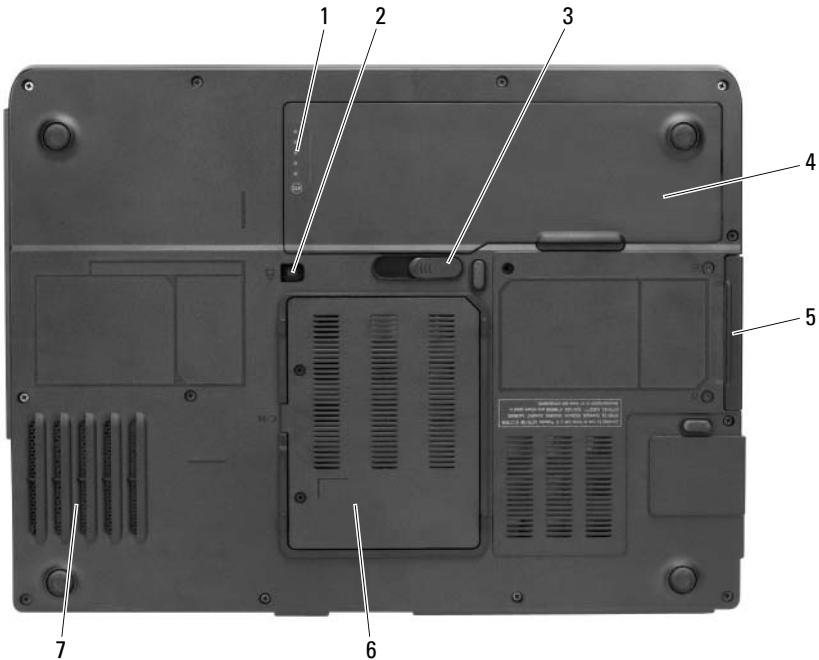

- |   |                      |   |                       |   |                           |
|---|----------------------|---|-----------------------|---|---------------------------|
| 1 | battery charge gauge | 2 | device security screw | 3 | battery-bay latch release |
| 4 | battery              | 5 | hard drive            | 6 | modem/memory module cover |
| 7 | fan                  |   |                       |   |                           |

**BATTERY CHARGE GAUGE** — Provides information on the battery charge status. See "Checking the Battery Charge" on page 54.

**DEVICE SECURITY SCREW** — Secures the optical drive in the optical drive bay. For more information, see "Optical Drive" on page 92.

**BATTERY-BAY LATCH RELEASE** — Releases the battery from the battery bay. See "Replacing the Battery" on page 59.

**BATTERY** — When a battery is installed, you can use the computer without connecting the computer to an electrical outlet. For more information, see "Using a Battery" on page 53.

**HARD DRIVE** — Stores software and data. For more information, see "Hard Drive" on page 92 and "Hard drive problems" on page 120.

**MODEM/MEMORY MODULE COVER** — Covers the compartment that contains the modem and the memory modules. For more information, see "Modem" on page 98 and "Memory" on page 95.

**FAN** — The computer uses a fan to create airflow through the vents, which prevents the computer from overheating.

# Setting Up Your Computer

## Connecting to the Internet

 **NOTE:** ISPs and ISP offerings vary by country.

To connect to the Internet, you need a modem or network connection and an Internet service provider (ISP). Your ISP will offer one or more of the following Internet connection options:

- Dial-up connections that provide Internet access through a telephone line. Dial-up connections are considerably slower than DSL and cable modem connections.
- DSL connections that provide high-speed Internet access through your existing telephone line. With a DSL connection, you can access the Internet and use your telephone on the same line simultaneously.
- Cable modem connections that provide high-speed Internet access through your local cable TV line.

If you are using a dial-up connection, connect a telephone line to the modem connector on your computer and to the telephone wall jack before you set up your Internet connection. If you are using a DSL or cable modem connection, contact your ISP for setup instructions.

## Setting Up Your Internet Connection

To set up an Internet connection with a provided ISP desktop shortcut:

- 1 Save and close any open files, and exit any open programs.
- 2 Double-click the ISP icon on the Microsoft® Windows® desktop.
- 3 Follow the instructions on the screen to complete the setup.



If you do not have an ISP icon on your desktop or if you want to set up an Internet connection with a different ISP, perform the steps in the following section that corresponds to the operating system your computer is using.

 **NOTE:** If you cannot connect to the Internet but have successfully connected in the past, the ISP might have a service outage. Contact your ISP to check the service status, or try connecting again later.

## Windows XP

- 1 Save and close any open files, and exit any open programs.
  - 2 Click **Start**→ **Internet Explorer**.  
The **New Connection Wizard** appears.
  - 3 Click **Connect to the Internet**.
  - 4 In the next window, click the appropriate option:
    - If you do not have an ISP and want to select one, click **Choose from a list of Internet service providers (ISPs)**.
    - If you have already obtained setup information from your ISP but you did not receive a setup CD, click **Set up my connection manually**.
    - If you have a CD, click **Use the CD I got from an ISP**.
  - 5 Click **Next**.  
If you selected **Set up my connection manually**, continue to step 6.  
Otherwise, follow the instructions on the screen to complete the setup.
-  **NOTE:** If you do not know which type of connection to select, contact your ISP.
- 6 Click the appropriate option under **How do you want to connect to the Internet?**, and then click **Next**.
  - 7 Use the setup information provided by your ISP to complete the setup.

## Windows Vista®

-  **NOTE:** Have your ISP information ready. If you do not have an ISP, the **Connect to the Internet** wizard can help you get one.
- 1 Save and close any open files, and exit any open programs.
  - 2 Click the Windows Vista Start button , and click **Control Panel**.
  - 3 Under **Network and Internet**, click **Connect to the Internet**.  
The **Connect to the Internet** window appears.
  - 4 Click either **Broadband (PPPoE)** or **Dial-up**, depending on how you want to connect:
    - Choose **Broadband** if you will use a DSL, satellite modem, cable TV modem, or Bluetooth wireless technology connection.
    - Choose **Dial-up** if you will use a dial-up modem or ISDN.



**NOTE:** If you do not know which type of connection to select, click **Help me choose** or contact your ISP.

Follow the instructions on the screen and use the setup information provided by your ISP to complete the setup.

## Transferring Information to a New Computer

You can use your operating system "wizards" to help you transfer files and other data from one computer to another—for example, from an *old* computer to a *new* computer. For instructions, see the following section that corresponds to the operating system that your computer is running.

### Microsoft® Windows® XP

The Microsoft Windows XP operating system provides the Files and Settings Transfer Wizard to move data from a source computer to a new computer. You can transfer data, such as:

- E-mail messages
- Toolbar settings
- Window sizes
- Internet bookmarks

You can transfer the data to the new computer over a network or serial connection, or you can store it on removable media, such as a writable CD, for transfer to the new computer.



**NOTE:** You can transfer information from an old computer to a new computer by directly connecting a serial cable to the input/output (I/O) ports of the two computers. To transfer data over a serial connection, you must access the Network Connections utility from the Control Panel and perform additional configuration steps, such as setting up an advanced connection and designating the host computer and the guest computer.

For instructions on setting up a direct cable connection between two computers, see Microsoft Knowledge Base Article #305621, titled *How to Set Up a Direct Cable Connection Between Two Computers in Windows XP*. This information may not be available in certain countries.

For transferring information to a new computer, you must run the Files and Settings Transfer Wizard. You can use the optional *Operating System* media for this process or you can create a wizard disk with the Files and Settings Transfer Wizard.

### Running the Files and Settings Transfer Wizard With the Operating System Media



**NOTE:** This procedure requires the *Operating System* media. This media is optional and may not be included with certain computers.

To prepare a new computer for the file transfer:

- 1 Open the Files and Settings Transfer Wizard: click **Start**→**All Programs**→**Accessories**→**System Tools**→**Files and Settings Transfer Wizard**.
- 2 When the **Files and Settings Transfer Wizard** welcome screen appears, click **Next**.
- 3 On the **Which computer is this?** screen, click **New Computer**→**Next**.
- 4 On the **Do you have a Windows XP CD?** screen, click **I will use the wizard from the Windows XP CD**→**Next**.
- 5 When the **Now go to your old computer** screen appears, go to your old or source computer. Do *not* click **Next** at this time.

To copy data from the old computer:

- 1 On the old computer, insert the Windows XP *Operating System* media.
- 2 On the **Welcome to Microsoft Windows XP** screen, click **Perform additional tasks**.
- 3 Under **What do you want to do?**, click **Transfer files and settings**→**Next**.
- 4 On the **Which computer is this?** screen, click **Old Computer**→**Next**.
- 5 On the **Select a transfer method** screen, click the transfer method you prefer.
- 6 On the **What do you want to transfer?** screen, select the items you want to transfer and click **Next**.

After the information has been copied, the **Completing the Collection Phase** screen appears.

- 7 Click **Finish**.

To transfer data to the new computer:

- 1 On the **Now go to your old computer** screen on the new computer, click **Next**.
- 2 On the **Where are the files and settings?** screen, select the method you chose for transferring your settings and files and click **Next**.  
The wizard reads the collected files and settings and applies them to your new computer.  
When all of the settings and files have been applied, the **Finished** screen appears.
- 3 Click **Finished** and restart the new computer.

### **Running the Files and Settings Transfer Wizard Without the Operating System Media**

To run the Files and Settings Transfer Wizard without the *Operating System* media, you must create a wizard disk that will allow you to create a backup image file to removable media.

To create a wizard disk, use your new computer with Windows XP and perform the following steps:

- 1 Open the Files and Settings Transfer Wizard: click **Start**→ **All Programs**→ **Accessories**→ **System Tools**→ **Files and Settings Transfer Wizard**.
- 2 When the **Files and Settings Transfer Wizard** welcome screen appears, click **Next**.
- 3 On the **Which computer is this?** screen, click **New Computer**→ **Next**.
- 4 On the **Do you have a Windows XP CD?** screen, click **I want to create a Wizard Disk in the following drive**→ **Next**.
- 5 Insert the removable media, such as a writable CD, and click **OK**.
- 6 When the disk creation completes and the **Now go to your old computer** message appears, *do not* click **Next**.
- 7 Go to the old computer.

To copy data from the old computer:

- 1 On the old computer, insert the wizard disk.
- 2 Click **Start**→ **Run**.

- 3 In the **Open** field in the **Run** window, browse to the path for **fastwiz** (on the appropriate removable media) and click **OK**.
- 4 On the **Files and Settings Transfer Wizard** welcome screen, click **Next**.
- 5 On the **Which computer is this?** screen, click **Old Computer**→ **Next**.
- 6 On the **Select a transfer method** screen, click the transfer method you prefer.
- 7 On the **What do you want to transfer?** screen, select the items you want to transfer and click **Next**.

After the information has been copied, the **Completing the Collection Phase** screen appears.

- 8 Click **Finish**.

To transfer data to the new computer:

- 1 On the **Now go to your old computer** screen on the new computer, click **Next**.
- 2 On the **Where are the files and settings?** screen, select the method you chose for transferring your settings and files and click **Next**. Follow the instructions on the screen.

The wizard reads the collected files and settings and applies them to your new computer.

When all of the settings and files have been applied, the **Finished** screen appears.

- 3 Click **Finished** and restart the new computer.



**NOTE:** For more information about this procedure, search [support.dell.com](http://support.dell.com) for document #154781 (*What Are The Different Methods To Transfer Files From My Old Computer To My New Dell™ Computer Using the Microsoft® Windows® XP Operating System?*).



**NOTE:** Access to the Dell™ Knowledge Base document may not be available in certain countries.

## Microsoft Windows Vista®

- 1 Click the Windows Vista Start button , and then click **Transfer files and settings**→ **Start Windows Easy Transfer**.



- 2 In the **User Account Control** dialog box, click **Continue**.
- 3 Click **Start a new transfer** or **Continue a transfer in progress**.



**NOTE:** Follow the instructions provided on the screen by the Windows Easy Transfer wizard.

## Setting Up a Printer



**NOTE:** Complete the operating system setup before you connect a printer to the computer.

See the documentation that came with the printer for setup information, including how to:

- Obtain and install updated drivers.
- Connect the printer to the computer.
- Load paper and install the toner or ink cartridge.

For technical assistance, refer to the printer owner's manual or contact the printer manufacturer.

### Printer Cable

Your printer connects to your computer with either a USB cable or a parallel cable. Your printer may not come with a printer cable, so if you purchase a cable separately, ensure that it is compatible with your printer and computer. If you purchased a printer cable at the same time you purchased your computer, the cable may arrive in the box in which your computer was shipped.

### Connecting a USB Printer



**NOTE:** You can connect USB devices while the computer is turned on.

- 1 Complete the operating system setup if you have not already done so.
- 2 Attach the USB printer cable to the USB connectors on the computer and the printer. The USB connectors fit only one way.

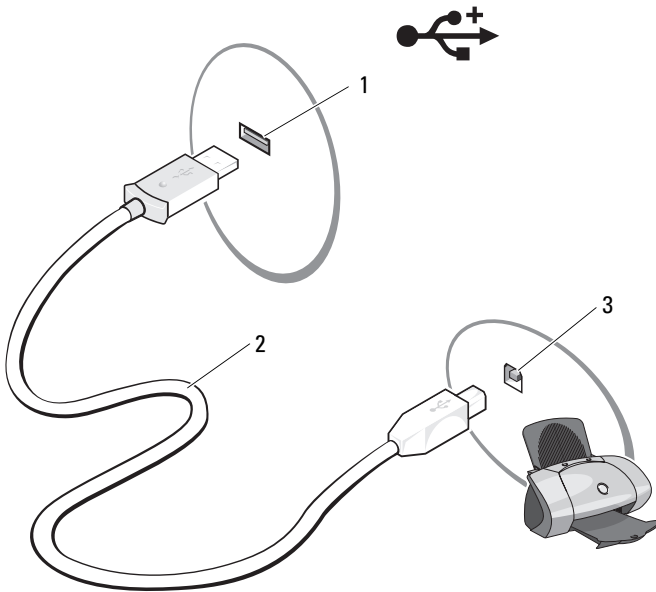

1 USB connector on computer      2 USB printer cable      3 connector on printer

- 3 Turn on the printer and then turn on the computer.
- 4 Depending on your computer's operating system, a printer wizard may be available to help you install the printer driver.
- 5 *If your computer is running the Microsoft® Windows® XP operating system and the **Add New Hardware Wizard** window appears, click **Cancel**.*  
*If your computer is running the Windows Vista® operating system, click the Windows Vista Start button , and click **Network→Add a printer** to start the **Add Printer Wizard**.*
- 6 Install the printer driver if necessary. See the documentation that came with your printer.

# Power Protection Devices

Several devices are available to protect against power fluctuations and failures:

- Surge protectors
- Line conditioners
- Uninterruptible power supplies (UPS)

## Surge Protectors

Surge protectors and power strips equipped with surge protection help prevent damage to your computer from voltage spikes that can occur during electrical storms or after power interruptions. Some surge protector manufacturers include warranty coverage for certain types of damage. Carefully read the device warranty when choosing a surge protector. A device with a higher joule rating offers more protection. Compare joule ratings to determine the relative effectiveness of different devices.

 **NOTICE:** Most surge protectors do not protect against power fluctuations or power interruptions caused by nearby lightning strikes. When lightning occurs in your area, disconnect the telephone line from the telephone wall jack and disconnect your computer from the electrical outlet.

Many surge protectors have a telephone jack for modem protection. See the surge protector documentation for modem connection instructions.

 **NOTICE:** Not all surge protectors offer network adapter protection. Disconnect the network cable from the network wall jack during electrical storms.

## Line Conditioners

 **NOTICE:** Line conditioners do not protect against power interruptions.

Line conditioners are designed to maintain AC voltage at a fairly constant level.

## Uninterruptible Power Supplies

 **NOTICE:** Loss of power while data is being saved to the hard drive may result in data loss or file damage.



**NOTE:** To ensure maximum battery operating time, connect only your computer to a UPS. Connect other devices, such as a printer, to a separate power strip that provides surge protection.

A UPS protects against power fluctuations and interruptions. UPS devices contain a battery that provides temporary power to connected devices when AC power is interrupted. The battery charges while AC power is available. See the UPS manufacturer documentation for information on battery operating time and to ensure that the device is approved by Underwriters Laboratories (UL).

# Using the Display

## Adjusting Brightness

When a Dell™ computer is running on battery power, you can conserve power by setting the brightness to the lowest comfortable setting by pressing <Fn> and the up- or down-arrow key on the keyboard.



**NOTE:** Brightness key combinations only affect the display on your portable computer, not monitors or projectors that you attach to your portable computer or docking device. If your computer is connected to an external monitor and you try to change the brightness level, the Brightness Meter may appear, but the brightness level on the external device does not change.

You can press the following keys to adjust display brightness:

- Press <Fn> and the up-arrow key to increase brightness on the integrated display only (not on an external monitor).
- Press <Fn> and the down-arrow key to decrease brightness on the integrated display only (not on an external monitor).

## Using a Projector

When you start the computer with an external device (such as an external monitor or projector) attached and turned on, the image may appear on either the computer display or the external device.

Press <Fn><F8> to switch the video image between the display only, the external device only, or the display and the external device simultaneously.

## Making Images and Text Look Bigger or Sharper



**NOTE:** If you change the display resolution from the current settings, the image may appear blurry or text may be hard to read if you change the resolution to one not supported by your computer and display. Before you change any of the display settings, make a note of the current settings so you can change back to the previous settings if you need to.

You can enhance the legibility of text and change the appearance of images on the screen by adjusting display resolution. As you increase resolution, items appear smaller on the screen. In contrast, lower resolution causes text and images to appear larger and can benefit people with vision impairments. To display a program at a specific resolution, both the video card and the display must support the program, and the necessary video drivers must be installed.

 **NOTE:** Use only the Dell-installed video drivers, which are designed to offer the best performance with your Dell-installed operating system.

If you choose a resolution or color palette that is higher than the display supports, the settings adjust automatically to the closest supported values.

To set the display resolution and refresh rate for your display, perform the steps in the following section that corresponds to the operating system your computer is using.

### **Microsoft® Windows® XP**

- 1 Click **Start**→ **Settings**→ **Control Panel**.
- 2 Under **Pick a category**, click **Appearance and Themes**.
- 3 Under **Pick a task...**, click the area you want to change, or under **or pick a Control Panel icon**, click **Display**.
- 4 In the **Display Properties** window, click the **Settings** tab.
- 5 Try different settings for **Color quality** and **Screen resolution**.

 **NOTE:** As the resolution increases, icons and text appear smaller on the screen.

### **Windows Vista®**

- 1 Click the Windows Vista Start button , and click **Control Panel**.
- 2 Under **Appearance and Personalization**, click **Adjust screen resolution**.
- 3 In the **Display Settings** window, under **Resolution**, slide the slide bar to the left/right to decrease/increase the screen resolution.
- 4 Click **How do I get the best display?** for further instructions.

If the video resolution setting is higher than that supported by the display, the computer enters pan mode. In pan mode, the entire video image cannot be displayed at one time, and the taskbar that usually appears at the bottom of

the desktop may no longer be visible. To view the parts of the video image that are not visible, you can use the touch pad or track stick to "pan" (or *move*) the image up, down, left, and right.



**NOTICE:** You can damage an external monitor by using an unsupported refresh rate. Before adjusting the refresh rate on an external monitor, see the user's guide for the monitor.

## Using Both a Monitor and Your Computer Display

You can attach an external monitor or projector to your computer and use it as an extension of your display (known as "dual independent display" or "extended desktop" mode). This mode allows you to use both screens independently and drag objects from one screen to the other, effectively doubling the amount of viewable work space.

To use extended desktop mode, perform the steps in the following section that corresponds to the operating system your computer is using.

### Microsoft® Windows® XP

- 1 Connect the external monitor, TV, or projector to the computer.
- 2 Click **Start**→ **Settings**→ **Control Panel**.
- 3 Under **Pick a category**, click **Appearance and Themes**.
- 4 Under **Pick a task...**, click the area you want to change, or under **or pick a Control Panel icon**, click **Display**.
- 5 In the **Display Properties** window, click the **Settings** tab.



**NOTE:** If you choose a resolution or color palette that is higher than the display supports, the settings adjust automatically to the closest supported values. For more information, see your operating system documentation.

- 6 Click the monitor 2 icon, click the **Extend my Windows desktop...** check box, and then click **Apply**.
- 7 Change **Screen Area** to the appropriate sizes for both displays and click **Apply**.
- 8 If prompted to restart the computer, click **Apply the new color setting without restarting** and click **OK**.
- 9 If prompted, click **OK** to resize your desktop.

- 10 If prompted, click **Yes** to keep the settings.
- 11 Click **OK** to close the **Display Properties** window.

To disable dual independent display mode:

- 1 Click the **Settings** tab in the **Display Properties** window.
- 2 Click the monitor 2 icon, uncheck the **Extend my Windows desktop onto this monitor** option, and then click **Apply**.

If necessary, press <Fn><F8> to bring the screen image back to the computer display.

### **Windows Vista®**

- 1 Click the Windows Vista Start button , and click **Control Panel**.
- 2 Under **Appearance and Personalization**, click **Adjust screen resolution**.
- 3 In the **Display Settings** window, click the monitor 2 icon, click the **Extend the desktop onto this monitor** check box, and then click **Apply**.
- 4 Click **OK** to close the **Display Settings** window.

To disable extended desktop mode:

- 1 In the **Display Settings** window, click the **Settings** tab.
- 2 Click the monitor 2 icon, uncheck the **Extend the desktop onto this monitor** option, and then click **Apply**.

## **Using a Monitor as Your Primary Display**

To swap your primary and secondary display designations (for example, to use your external monitor as your primary display after docking), perform the steps in the following section that corresponds to the operating system your computer is using.

### **Microsoft Windows XP**

- 1 Click the **Start** button and click **Control Panel**.
- 2 Under **Pick a category**, click **Appearance and Themes**.
- 3 Under **Pick a task...**, click the area you want to change, or under **or pick a Control Panel icon**, click **Display**.



- 4 Click the **Settings** tab→**Advanced**→**Displays** tab.

See the documentation that came with your video card for additional information.

## Windows Vista

- 1 Click the Windows Vista Start button , and click **Control Panel**.
- 2 Under **Appearance and Personalization**, click **Adjust screen resolution**.
- 3 In the **Display Settings** window, click the monitor 2 icon, click the **This is my main monitor** check box, and then click **Apply**.
- 4 Click **OK** to close the **Display Settings** window.

## Using Catalyst® Control Center

The ATI Catalyst Control Center is a graphical user interface that provides easy access to display features contained within the installed ATI hardware and software. The Catalyst Control Center optimizes your graphics settings, enables or disables connected graphics devices, and changes the orientation of your desktop. Many of the features show you a preview of the changes before they are applied.



**NOTE:** Microsoft .NET 1.1 or 2.0 must be installed to support the full functionality of the Catalyst Control Center.

The Catalyst Control Center provides two views of the software:

- Standard View is a simplified view that includes wizards to help the inexperienced user use the software.
- Advance View allows the advanced user to access and configure the complete feature set of the software.

You can customize the Catalyst Control Center for easy access to the features you use most.

Use the Catalyst Control Center to access a comprehensive online help system, or connect to the ATI web site for help.

## Launching Catalyst Control Center

You can launch Catalyst Control Center from any of the following access points:

- Windows Start menu
- Desktop shortcuts
- Predefined hot keys

### Using the Start Menu

From the Windows task bar, click **Start**→ **All Programs**→ **ATI Catalyst Control Center**→ **ATI Catalyst Control Center**.

### Using the Desktop Shortcut

When you install the Catalyst Control Center, the setup wizard provides an option to place a shortcut on the desktop. If you select this option, you can double-click the desktop shortcut to start the Catalyst Control Center.

### Using Hot Keys

You can press the predefined combination of keys <Ctrl><Alt><c> to launch Catalyst Control Center, or you can define your own hot key sequence by using the Catalyst Control Center's Hotkey Manager.

# Using the Keyboard and Touch Pad

## Numeric Keypad



The numeric keypad functions like the numeric keypad on an external keyboard. Each key on the keypad has multiple functions. The keypad numbers and symbols are marked in blue on the right of the keypad keys. To type a number or symbol, press <Fn> and the desired key after enabling the keypad.

- To enable the keypad, press <Fn><Num Lk>. The  light indicates that the keypad is active.
- To disable the keypad, press <Fn><Num Lk> again.

# Key Combinations

## System Functions

---

<Ctrl><Shift><Esc>	Opens the <b>Task Manager</b> window.
--------------------	---------------------------------------

---

## Battery

---

<Fn><F3>	Displays the Dell™ <b>QuickSet Battery Meter</b>
----------	--

---

## CD or DVD Tray

---

<Fn><F10>	Ejects the tray out of the drive (if Dell <b>QuickSet</b> is installed).
-----------	--

---

## Display Functions

---

<Fn><F8>	Displays icons representing all currently available display options (for example, display only, external monitor or projector only, both display and projector, and so on). Highlight the desired icon to switch the display to that option.
----------	--

---

---

<Fn> and up-arrow key	Increases brightness on the integrated display only (not on an external monitor).
-----------------------	---

---

---

<Fn> and down-arrow key	Decreases brightness on the integrated display only (not on an external monitor).
-------------------------	---

---

## Power Management

---

<Fn><Esc>	Activates a power management mode. You can reprogram this keyboard shortcut to activate a different power management mode using the <b>Advanced</b> tab in the <b>Power Options Properties</b> window.
-----------	--

---

---

<Fn><F1>	Puts the computer into hibernate mode. Dell <b>QuickSet</b> is required (see "Dell™ <b>QuickSet Features</b> " on page 159).
----------	--

---

## Speaker Functions

---

<Fn><Page Up>	Increases the volume of the integrated speakers and external speakers, if attached.
<Fn><Page Dn>	Decreases the volume of the integrated speakers and external speakers, if attached.
<Fn><End>	Enables and disables the integrated speakers and external speakers, if attached.

---

## Microsoft® Windows® Logo Key Functions

---

Windows logo key and <m>	Minimizes all open windows.
Windows logo key and <Shift><m>	Restores all minimized windows. This command functions as a toggle to restore (maximize) all windows previously minimized with the use of the Windows logo key and <m> key combination.
Windows logo key and <e>	Runs Windows Explorer.
Windows logo key and <r>	Opens the <b>Run</b> dialog box.
Windows logo key and <f>	Opens the <b>Search Results</b> dialog box.
Windows logo key and <Ctrl><f>	Opens the <b>Search Results-Computer</b> dialog box (if the computer is connected to a network).
Windows logo key and <Pause>	Opens the <b>System Properties</b> dialog box.

---

## Adjusting Keyboard Settings

To adjust keyboard operation, such as the character repeat rate, open the Control Panel and click **Keyboard**. For information about the Control Panel, see the Windows Help and Support Center. To access the Help and Support Center, see "Windows Help and Support Center" on page 17.

# Touch Pad

The touch pad detects the pressure and movement of your finger to allow you to move the cursor on the display. Use the touch pad and touch pad buttons as you would use a mouse.

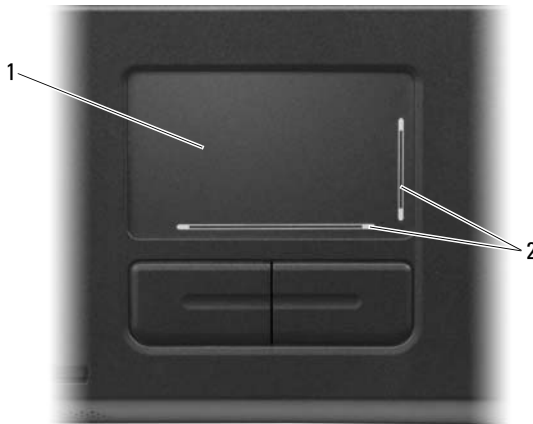

1 touch pad

2 silk-screen with scroll zones

- To move the cursor, lightly slide your finger over the touch pad.
- To select an object, position the cursor on the object and lightly tap once on the surface of the touch pad or use your thumb to press the left touch-pad button.
- To select and move (or drag) an object, position the cursor on the object and tap twice on the touch pad. On the second tap, leave your finger on the touch pad and move the selected object by sliding your finger over the surface.
- To double-click an object, position the cursor on the object and tap twice on the touch pad or use your thumb to press the left touch-pad button twice.

The touch pad has silk screening on two sides to indicate scrolling capability in these scroll zones. Scrolling is enabled by default. To disable this feature, modify the mouse properties through the Control Panel.



**NOTE:** The scroll zones may not work with all programs. For the scroll zones to function properly, the program must be able to use the touch-pad scroll feature.

## Customizing the Touch Pad

You can use the **Mouse Properties** window to disable the touch pad or adjust its settings.

- 1 Open the Control Panel, click **Printers and Other Hardware**, and then click **Mouse**. For information about the Control Panel, see the Windows Help and Support Center. To access the Help and Support Center, see "Windows Help and Support Center" on page 17.
- 2 In the **Mouse Properties** window, click the **Pointer Options** tab to adjust touch pad settings.
- 3 Click **OK** to save the settings and close the window.







# Using a Battery

## Battery Performance

 **NOTE:** For information about the Dell warranty for your computer, see the *Product Information Guide* or separate paper warranty document that shipped with your computer.

For optimal computer performance and to help preserve BIOS settings, operate your Dell™ portable computer with the battery installed at all times. One battery is supplied as standard equipment in the battery bay.

 **NOTE:** Because the battery may not be fully charged, use the AC adapter to connect your new computer to an electrical outlet the first time you use the computer. For best results, operate the computer with the AC adapter until the battery is fully charged. To view battery charge status, access the Control Panel, click **Power Options**, and then click the **Power Meter** tab.

 **NOTE:** Battery operating time (the time the battery can hold a charge) decreases over time. Depending on how often the battery is used and the conditions under which it is used, you may need to purchase a new battery during the life of your computer.

Battery operating time varies depending on operating conditions. Operating time is significantly reduced when you perform operations including, but not limited to, the following:

- Using optical drives
- Using wireless communications devices, ExpressCards, media memory cards, or USB devices
- Using high-brightness display settings, 3D screen savers, or other power-intensive programs such as complex 3D graphics applications
- Running the computer in maximum performance mode (See "Configuring Power Management Settings" on page 58.)

 **NOTE:** It is recommended that you connect your computer to an electrical outlet when writing to a CD or DVD.

You can check the battery charge (see "Checking the Battery Charge" on page 54) before you insert the battery into the computer. You can also set power management options to alert you when the battery charge is low. See "Configuring Power Management Settings" on page 58 for information about accessing the **Power Options Properties** window.

 **CAUTION: Using an incompatible battery may increase the risk of fire or explosion. Replace the battery only with a compatible battery purchased from Dell. The battery is designed to work with your Dell computer. Do not use a battery from other computers with your computer.**

 **CAUTION: Do not dispose of batteries with household waste. When your battery no longer holds a charge, call your local waste disposal or environmental agency for advice on disposing of a lithium-ion battery. See "Battery Disposal" in the *Product Information Guide*.**

 **CAUTION: Misuse of the battery may increase the risk of fire or chemical burn. Do not puncture, incinerate, disassemble, or expose the battery to temperatures above 65°C (149°F). Keep the battery away from children. Handle damaged or leaking batteries with extreme care. Damaged batteries may leak and cause personal injury or equipment damage.**

## Checking the Battery Charge

The Dell QuickSet Battery Meter, the Microsoft® Windows® Power Meter window and  icon, the battery charge gauge and health gauge, and the low-battery warning provide information on the battery charge.

### Dell™ QuickSet Battery Meter

If Dell QuickSet is installed, press <Fn><F3> to display the QuickSet Battery Meter. The Battery Meter displays status, battery health, charge level, and charge completion time for the battery in your computer.

For more information about QuickSet, right-click the QuickSet icon in the taskbar, and click **Help**.

## Microsoft® Windows® Power Meter

The Windows Power Meter indicates the remaining battery charge. To check the Power Meter, double-click the  icon on the taskbar. For instructions on accessing more information about the Power Meter, see "Configuring Power Management Settings" on page 58.

If the computer is connected to an electrical outlet, a  icon appears.

## Charge Gauge

By either pressing once or *pressing and holding* the status button on the charge gauge on the battery, you can check:

- Battery charge (check by pressing and *releasing* the status button)
- Battery health (check by pressing and *holding* the status button)

The battery operating time is largely determined by the number of times it is charged. After hundreds of charge and discharge cycles, batteries lose some charge capacity—or battery health. That is, a battery can show a status of "charged" but maintain a reduced charge capacity (health).

### Check the Battery Charge

To check the battery charge, *press and release* the status button on the battery charge gauge to illuminate the charge-level lights. Each light represents approximately 20 percent of the total battery charge. For example, if four of the lights are on, the battery has 80 percent of its charge remaining. If no lights appear, the battery has no charge.

### Check the Battery Health

To check the battery health using the charge gauge, *press and hold* the status button on the battery charge gauge for at least 3 seconds. If no lights appear, the battery is in good condition, and more than 80 percent of its original charge capacity remains. Each light represents incremental degradation. If five lights appear, less than 60 percent of the charge capacity remains, and you should consider replacing the battery. See "Specifications" on page 167 for more information about the battery operating time.

## Low-Battery Warning

- ➔ **NOTICE:** To avoid losing or corrupting data, save your work immediately after a low-battery warning, and then connect the computer to an electrical outlet. If the battery runs completely out of power, hibernate mode begins automatically.

By default, a pop-up window warns you when the battery charge is approximately 90 percent depleted. You can change the settings for the battery alarms. See "Configuring Power Management Settings" on page 58 for information about accessing the **Power Options Properties** window.

## Conserving Battery Power

Perform the following actions to conserve battery power:

- Connect the computer to an electrical outlet when possible because battery life is largely determined by the number of times the battery is used and recharged.
- Place the computer in standby mode or hibernate mode when you leave the computer unattended for long periods of time. See "Power Management Modes" on page 56 for more information about standby and hibernate modes.
- Select options to optimize your computer's power usage. These options can also be set to change when you press the power button, close the display, or press <Fn><Esc>. See "Configuring Power Management Settings" on page 58 for more information.

-  **NOTE:** See "Battery Performance" on page 53 for more information on conserving battery power.

## Power Management Modes

### Standby Mode

Standby mode (sleep mode in Microsoft Windows Vista®) conserves power by turning off the display and the hard drive after a predetermined period of inactivity (a time-out). When the computer exits standby or sleep mode, it returns to the same operating state it was in before entering standby or sleep mode.

- ➔ **NOTICE:** If your computer loses AC and battery power while in standby or sleep mode, it may lose data.

To enter standby mode in Windows XP, click the **Start** button, click **Turn off computer**, and then click **Stand by**.

To enter sleep mode in Windows Vista, click the Windows Vista Start button , and then click **Sleep**.

- Depending on how you set the power management options in the **Power Options Properties** window or the **QuickSet Power Management Wizard**, you may also use one of the following methods:
  - Press the power button.
  - Close the display.
  - Press <Fn><Esc>.

To exit standby mode, press the power button or open the display depending on how you set the options on the **Advanced** tab. You cannot make the computer exit standby mode by pressing a key or touching the touch pad.

## **Hibernate Mode**

Hibernate mode conserves power by copying system data to a reserved area on the hard drive and then completely turning off the computer. When the computer exits hibernate mode, it returns to the same operating state it was in before entering hibernate mode.



**NOTICE:** You cannot remove devices or undock your computer while your computer is in hibernate mode.

Your computer enters hibernate mode if the battery charge level becomes critically low.

To manually enter hibernate mode in Windows XP, click the **Start** button, click **Turn off computer**, press and hold <Shift>, and then click **Hibernate**.

To manually enter hibernate mode in Windows Vista, click the Windows Vista Start button , and then click **Hibernate**.

Depending on how you set the power management options in the **Power Options Properties** window or the **QuickSet Power Management Wizard**, you may also use one of the following methods to enter hibernate mode:

- Press the power button.
- Close the display.
  - Press <Fn><Esc>.

 **NOTE:** Some ExpressCards may not operate correctly after the computer exits hibernate mode. Remove and reinsert the card (see "Removing an ExpressCard or Blank" on page 71), or simply restart (reboot) your computer.

To exit hibernate mode, press the power button. The computer may take a short time to exit hibernate mode. You cannot make the computer exit hibernate mode by pressing a key or touching the touch pad. For more information on hibernate mode, see the documentation that came with your operating system.

## Configuring Power Management Settings

You can use the QuickSet Power Management Wizard or Windows Power Options Properties to configure the power management settings on your computer. For more information about QuickSet, right-click the QuickSet icon in the taskbar and click **Help**.

## Accessing Power Options Properties

### Windows XP

Click the **Start** button, point to **Control Panel**→**Performance and Maintenance**, and then click **Power Options**

### Windows Vista

Click the Windows Vista Start button , click **Control Panel**, click **System and Maintenance**, and then click **Power Options**.

## Charging the Battery

When you connect the computer to an electrical outlet or install a battery while the computer is connected to an electrical outlet, the computer checks the battery charge and temperature. If necessary, the AC adapter then charges the battery and maintains the battery charge.

 **NOTE:** With Dell™ ExpressCharge™, when the computer is turned off, the AC adapter charges a completely discharged battery to 80 percent in about 1 hour and to 100 percent in approximately 2 hours. Charge time is longer with the computer turned on. You can leave the battery in the computer for as long as you like. The battery's internal circuitry prevents the battery from overcharging.

If the battery is hot from being used in your computer or being in a hot environment, the battery may not charge when you connect the computer to an electrical outlet.

The battery is too hot to start charging if the  light flashes alternately green and orange. Disconnect the computer from the electrical outlet and allow the computer and the battery to cool to room temperature. Then connect the computer to an electrical outlet to continue charging the battery.

For more information about resolving problems with a battery, see "Power Problems" on page 135.

## Replacing the Battery

 **CAUTION:** Before performing these procedures, turn off the computer, disconnect the AC adapter from the electrical outlet and the computer, disconnect the modem from the wall connector and computer, and remove any other external cables from the computer.

 **NOTICE:** You must remove all external cables from the computer to avoid possible connector damage.

 **CAUTION:** Using an incompatible battery may increase the risk of fire or explosion. Replace the battery only with a compatible battery purchased from Dell. The battery is designed to work with your Dell™ computer; do not use a battery from other computers.

 **NOTICE:** If you choose to replace the battery with the computer in standby mode, you have up to 1 minute to complete the battery replacement before the computer shuts down and loses any unsaved data.

To remove the battery:

- 1 If the computer is connected to a docking device (docked), undock it. See the documentation that came with your docking device for instructions.
- 2 Ensure that the computer is turned off.
- 3 Slide and hold the battery-bay latch release on the bottom of the computer, and then lift the battery from the bay.

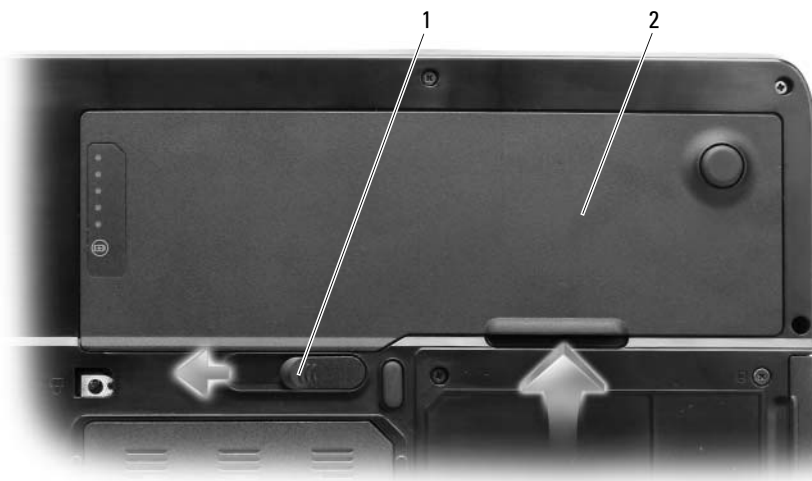

- 1 battery-bay latch release      2 battery

To replace the battery, follow the removal procedure in reverse order.

## Storing a Battery

Remove the battery when you store your computer for an extended period of time. A battery discharges during prolonged storage. After a long storage period, recharge the battery fully (see "Charging the Battery" on page 58) before you use it.



# Using Multimedia

## Playing a CD or DVD

➡ **NOTICE:** Do not press down on the CD or DVD tray when you open or close it. Keep the tray closed when you are not using the drive.

📎 **NOTE:** Do not move the computer when you are playing CDs or DVDs. Press the eject button on the front of the drive.

- 1 Press the eject button on the front of the drive.
- 2 Pull out the tray.



1 CD/DVD tray

- 3 Place the disc, label side up, in the center of the tray and snap the disc onto the spindle.

 **NOTE:** If you use a CD/DVD drive that shipped with another computer, you need to install the drivers and software necessary to play CDs or DVDs or write data. For more information, see the *Drivers and Utilities* media (the *Drivers and Utilities* media is optional and may not be available for your computer or in certain countries).

- 4 Push the tray back into the drive.

To format CDs for storing data, to create music CDs, or to copy CDs, see the CD software that came with your computer.

 **NOTE:** Ensure that you obey all copyright laws when you create CDs.

## Adjusting the Volume

 **NOTE:** When the speakers are muted, you do not hear the CD or DVD playing.

- 1 Click the **Start** button, point to **Programs**→**Accessories**→**Entertainment** (or **Multimedia**), and then click **Volume Control**.
- 2 In the **Volume Control** window, click and drag the bar in the **Volume Control** column and slide it up or down to increase or decrease the volume.

For more information on volume control options, click **Help** in the **Volume Control** window.

Adjust the volume with the volume control buttons or by pressing the following key combinations:

- Press <Fn><Page Up> to increase the volume.
- Press <Fn><Page Down> to decrease the volume.
- Press <Fn><End> to mute the volume.

## Adjusting the Picture

If an error message notifies you that the current resolution and color depth are using too much memory and preventing DVD playback, adjust the display properties.

- 1 Click the **Start** button and click **Control Panel**.
- 2 Under **Pick a category**, click **Appearance and Themes**.

- 3 Under **Pick a task...**, click **Change the screen resolution**.
- 4 In the **Display Properties** window, click and drag the bar in **Screen resolution** to reduce the screen resolution setting.
- 5 Click the drop-down menu under **Color quality**, and then click **Medium (16 bit)**.
- 6 Click **OK** to save the settings and close the window.

## Copying CDs and DVDs

 **NOTE:** Ensure that you observe all copyright laws when creating CDs or DVDs.

This section applies only to computers that have a CD-RW, DVD+/-RW, or CD-RW/DVD (combo) drive.

 **NOTE:** The types of CD or DVD drives offered by Dell may vary by country.

The following instructions explain how to make an exact copy of a CD or DVD. You can also use Sonic DigitalMedia for other purposes, such as creating music CDs from audio files stored on your computer or backing up important data. For help, open Sonic DigitalMedia and then click the question mark icon in the upper-right corner of the window.

### How to Copy a CD or DVD

 **NOTE:** CD-RW/DVD combo drives cannot write to DVD media. If you have a CD-RW/DVD combo drive and you experience recording problems, check for available software patches on the Sonic support website at [www.sonic.com](http://www.sonic.com).

The DVD-writable drives installed in Dell™ computers can write to and read DVD+/-R, DVD+/-RW and DVD+R DL (dual layer) media, but cannot write to and may not read DVD-RAM or DVD-R DL media.

 **NOTE:** Most commercial DVDs have copyright protection and cannot be copied using Sonic DigitalMedia.

- 1 Click the **Start** button, point to **Programs**→ **Sonic**→ **DigitalMedia Projects**, and then click **Copy**.
- 2 Under the **Copy** tab, click **Disc Copy**.

### 3 To copy the CD or DVD:

- *If you have one CD or DVD drive*, ensure that the settings are correct and click the **Disc Copy** button. The computer reads your source CD or DVD and copies the data to a temporary folder on your computer hard drive.

When prompted, insert a blank CD or DVD into the drive and click **OK**.

- *If you have two CD or DVD drives*, select the drive into which you have inserted your source CD or DVD and click the **Disc Copy** button. The computer copies the data from the source CD or DVD to the blank CD or DVD.

Once you have finished copying the source CD or DVD, the CD or DVD that you have created automatically ejects.

## Using Blank CDs and DVDs

CD-RW drives can write to CD recording media only (including high-speed CD-RW) while DVD-writable drives can write to both CD and DVD recording media.

Use blank CD-Rs to record music or permanently store data files. After creating a CD-R, you cannot write to that CD-R again (see the Sonic documentation for more information). Use blank CD-RWs to write to CDs or to erase, rewrite, or update data on CDs.

Blank DVD+/-Rs can be used to permanently store large amounts of information. After you create a DVD+/-R disc, you may not be able to write to that disc again if the disc is "finalized" or "closed" during the final stage of the disc creation process. Use blank DVD+/-RWs if you plan to erase, rewrite, or update information on that disc later.

### CD-Writable Drives

Media Type	Read	Write	Rewritable
CD-R	Yes	Yes	No
CD-RW	Yes	Yes	Yes

## DVD-Writable Drives

Media Type	Read	Write	Rewritable
CD-R	Yes	Yes	No
CD-RW	Yes	Yes	Yes
DVD+R	Yes	Yes	No
DVD-R	Yes	Yes	No
DVD+RW	Yes	Yes	Yes
DVD-RW	Yes	Yes	Yes
DVD+R DL	Yes	Yes	No
DVD-R DL	Maybe	No	No
DVD-RAM	Maybe	No	No

## Helpful Tips

- Use Microsoft® Windows® Explorer to drag and drop files to a CD-R or CD-RW only after you start Sonic DigitalMedia and open a DigitalMedia project.
- Use CD-Rs to burn music CDs that you want to play in regular stereos. CD-RWs do not play in most home or car stereos.
- You cannot create audio DVDs with Sonic DigitalMedia.
- Music MP3 files can be played only on MP3 players or on computers that have MP3 software installed.
- Commercially available DVD players used in home theater systems may not support all available DVD formats. For a list of formats supported by your DVD player, see the documentation provided with your DVD player or contact the manufacturer.
- Do not burn a blank CD-R or CD-RW to its maximum capacity; for example, do not copy a 650-MB file to a blank 650-MB CD. The CD-RW drive needs 1–2 MB of the blank space to finalize the recording.

- Use a blank CD-RW to practice CD recording until you are familiar with CD recording techniques. If you make a mistake, you can erase the data on the CD-RW and try again. You can also use blank CD-RWs to test music file projects before you record the project permanently to a blank CD-R.
- See the Sonic website at [www.sonic.com](http://www.sonic.com) for additional information.

## Adjusting the Volume

 **NOTE:** When the speakers are muted, you do not hear the CD or DVD playing.

- 1 Open the **Volume Control** window.
- 2 Click and drag the bar in the **Volume Control** column and slide it up or down to increase or decrease the volume.

For more information on volume control options, click **Help** in the **Volume Control** window.

The Volume Meter displays the current volume level, including mute, on your computer. Either click the **QuickSet** icon in the taskbar and select or deselect **Disable On Screen Volume Meter**, or press the volume control buttons to enable or disable the Volume Meter on the screen.

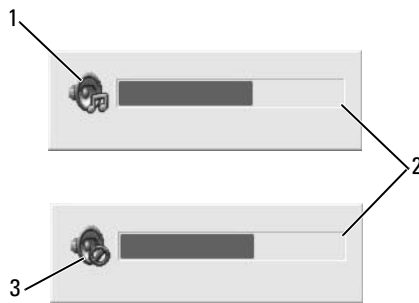

1 volume icon

2 Volume Meter

3 mute icon

When the meter is enabled, adjust the volume with the volume control buttons or by pressing the following keys:

- Press <Fn><Page Up> to increase volume.
- Press <Fn><Page Down> to decrease volume.
- Press <Fn><End> to mute volume.

For more information about QuickSet, right-click the icon in the taskbar and click **Help**.

## Adjusting the Picture

If an error message notifies you that the current resolution and color depth are using too much memory and preventing DVD playback, adjust the display properties.

*Microsoft Windows XP*

- 1** Click **Start**→ **Control Panel**→ **Appearance and Themes**.
- 2** Under **Pick a task...**, click **Change the screen resolution**. Under **Screen resolution**, click and drag the bar to reduce the resolution setting.
- 3** In the drop-down menu under **Color quality**, click **Medium (16 bit)** and click **OK**.

*Microsoft Windows Vista® Operating System*

- 1** Click the Windows Vista Start button , click **Control Panel**, and then click **Appearance and Personalization**.
- 2** Under **Personalization**, click **Adjust Screen Resolution**.  
The **Display Properties** window appears.
- 3** Under **Resolution**: click and drag the bar to reduce the resolution setting.
- 4** In the drop-down menu under **Colors**:, click **Medium (16 bit)**.
- 5** Click **OK**.





# Using Cards

## ExpressCards

ExpressCards provide additional memory, wired and wireless communications, multimedia and security features. ExpressCards support two form factors:

- ExpressCard/34 (34 mm wide)
- ExpressCard/54 (54 mm wide in an L-shape with a 34 mm connector)

The 34 mm card fits into both the 34 mm and 54 mm card slots. The 54 mm card only fits into a 54 mm card slot.

See "Specifications" on page 167 for information on supported ExpressCards.



**NOTE:** An ExpressCard is not a bootable device.

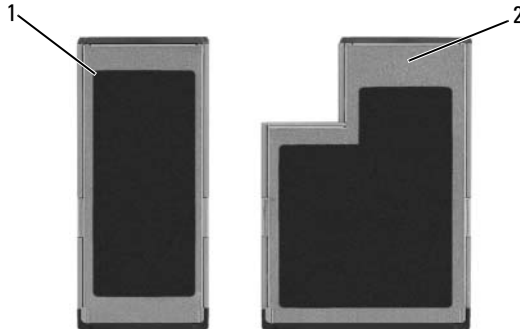

1 Express Card/34

2 ExpressCard/54

## ExpressCard Blanks

Your computer shipped with a plastic blank installed in the ExpressCard slot. Blanks protect unused slots from dust and other particles. Save the blank for use when no ExpressCard is installed in the slot; blanks from other computers may not fit your computer.

To remove the blank, see "Removing an ExpressCard or Blank" on page 71.

## Installing an ExpressCard

You can install an ExpressCard in the computer while the computer is running. The computer automatically detects the card.

ExpressCards are generally marked with a symbol (such as a triangle or an arrow) or a label to indicate which end to insert into the slot. The cards are keyed to prevent incorrect insertion. If card orientation is not clear, see the documentation that came with the card.

**⚠ CAUTION:** Before you begin any of the procedures in this section, follow the safety instructions in the *Product Information Guide*.

To install an ExpressCard:

- 1 Hold the card with the top side of the card facing up. The latch may need to be in the "in" position before you insert the card.
- 2 Slide the card into the slot until the card is completely seated in its connector.

If you encounter too much resistance, do not force the card. Check the card orientation and try again.



1 ExpressCard

The computer recognizes the ExpressCard and automatically loads the appropriate device driver. If the configuration program tells you to load the manufacturer's drivers, use the floppy disk or CD that came with the ExpressCard.

## Removing an ExpressCard or Blank

**⚠ CAUTION:** Before you begin any of the procedures in this section, follow the safety instructions in the *Product Information Guide*.

**➡ NOTICE:** Use the ExpressCard configuration utility (click the  icon in the taskbar) to select a card and stop it from functioning before you remove it from the computer. If you do not stop the card in the configuration utility, you could lose data.

Press the release latch and remove the card or blank. For some latches, you must press the latch twice: once to pop the latch out, and then a second time to pop the card out.

Save a blank to use when no ExpressCard is installed in a slot. Blanks protect unused slots from dust and other particles.



1 release latch

2 ExpressCard

## Media Memory Cards

The 3-in-1 media memory card reader provides a fast and convenient way to view and share digital photos, music, and videos stored on a media memory card.



**NOTE:** A media memory card is not a bootable device.

The 3-in-1 media memory card reader reads Secure Digital (SD) card/SDIO and MultiMediaCard (MMC) media memory cards.

### Installing a Media Memory Card

You can install a media memory card in the computer while the computer is running. The computer automatically detects the card.

Media memory cards are generally marked with a symbol (such as a triangle or an arrow) or a label to indicate which end to insert into the slot. The cards are keyed to prevent incorrect insertion. If card orientation is not clear, see the documentation that came with the card.



**CAUTION:** Before you begin any of the procedures in this section, follow the safety instructions in the *Product Information Guide*.

To install a media memory card:

- 1 Hold the card with the top side of the card facing up.
- 2 Slide the card into the slot until the card is completely seated in its connector.

If you encounter too much resistance, do not force the card. Check the card orientation and try again.





1 media memory card slot

2 media memory card

The computer recognizes the media memory card and automatically loads the appropriate device driver. If the configuration program tells you to load the manufacturer's drivers, use the CD that came with the media memory card, if applicable.

### Removing a Media Memory Card

 **CAUTION:** Before you begin any of the procedures in this section, follow the safety instructions in the *Product Information Guide*.

 **NOTICE:** Use the media memory card configuration utility (click the  icon in the taskbar) to select a card and stop it from functioning before you remove it from the computer. If you do not stop the card in the configuration utility, you could lose data.

Press the card in to release it from the card reader so that it is partially ejected, and remove the card.



# Setting Up and Using Networks

## Physically Connecting to a Network or Broadband Modem

Setting up a computer network provides connectivity between your computer and the Internet, another computer, or a network. For example, with a network set up in a home or small office you can print to a shared printer, access drives and files on another computer, browse other networks, or access the Internet. You can set up a local area network (LAN) using a network or broadband modem cable or set up a wireless LAN (WLAN).

The Microsoft® Windows® XP and Microsoft Windows Vista® operating systems provide wizards to help guide you through the process of networking computers.

## Connecting a Network or Broadband Modem Cable

Before you connect your computer to a network that is not wireless, the computer must have a network adapter installed and a network cable connected to it.

To connect a network cable:

- 1 Connect the network cable to the network adapter connector on the back of your computer.



**NOTE:** Insert the cable connector until it clicks into place, and then gently pull the cable to ensure that it is securely attached.

- 2 Connect the other end of the network cable to a network connection device or a network wall connector.



Do not use a network cable with a telephone wall connector.



## Setting Up a Network in the Microsoft® Windows® XP Operating System

- 1 Click Start→ All Programs→ Accessories→ Communications→ Network Setup Wizard→ Next→ Checklist for creating a network.

 **NOTE:** Selecting the connection method labeled **This computer connects directly to the Internet** enables the integrated firewall provided with Windows XP Service Pack 2 (SP2).

- 2 Complete the checklist.
- 3 Return to the Network Setup Wizard and follow the instructions in the wizard.

## Setting Up a Network in the Microsoft Windows Vista® Operating System

- 1 Click the Windows Vista Start button  → and then click **Connect To**→ **Set up a connection or network**.
- 2 Select an option under **Choose a connection option**.
- 3 Click **Next**, and then follow the instructions in the wizard.



## Wireless Local Area Network (WLAN)

A WLAN is a series of interconnected computers that communicate with each other over the air waves rather than through a network cable connected to each computer. In a WLAN, a radio communications device called an access point or wireless router connects network computers and provides network access. The access point or wireless router and the wireless network card in the computer communicate by broadcasting data from their antennas over the air waves.

### What You Need to Establish a WLAN Connection

Before you can set up a WLAN, you need:

- High-speed (broadband) Internet access (such as cable or DSL)
- A broadband modem that is connected and working
- A wireless router or access point
- A wireless network card for each computer that you want to connect to your WLAN
- A network cable with the network (RJ-45) connector

### Checking Your Wireless Network Card

Depending on what you selected when you purchased your computer, the computer has a variety of configurations. To confirm that your computer has a wireless network card and to determine the type of card, use one of the following:

- The **Start** button and the **Connect To** option
- Your order confirmation

#### Start Button and Connect To Option

*In Microsoft Windows XP, click **Start**→ **Connect To**→ **Show all connections**.*



**NOTE:** If your computer is set to the **Classic Start** menu option, click **Start**→ **Settings**→ **Network Connections** to view your network connections.

*In Microsoft Windows Vista, click the Windows Vista Start button → **Connect To**→ **View network computers and devices**.*

If Wireless Network Connection does not appear under LAN or High-Speed Internet, you may not have a wireless network card.

If Wireless Network Connection appears, you have a wireless network card. To view detailed information about the wireless network card:

- 1 Right-click **Wireless Network Connection**.
- 2 Click **Properties**.

The **Wireless Network Connection Properties** window appears. The wireless network card's name and model number are listed on the **General** tab.



**NOTE:** If **Wireless Network Connection** does not appear, you may not have a wireless network card.

### **The Order Confirmation for Your Computer**

The order confirmation that you received when you ordered your computer lists the hardware and software that shipped with your computer.

### **Setting Up a New WLAN Using a Wireless Router and a Broadband Modem**

- 1 Contact your Internet service provider (ISP) to obtain specific information about the connection requirements for your broadband modem.
- 2 Ensure that you have wired Internet access through your broadband modem before you attempt to set up a wireless Internet connection (see "Connecting a Network or Broadband Modem Cable" on page 75).
- 3 Install any software required for your wireless router. Your wireless router may have been shipped with an installation CD. Installation CDs usually contain installation and troubleshooting information. Install the required software according to the instructions provided by the router manufacturer.
- 4 Shut down your computer and any other wireless-enabled computers in the vicinity through the Windows XP **Start** menu or the Windows Vista Start button  menu.
- 5 Disconnect your broadband modem power cable from the electrical outlet.
- 6 Disconnect the network cable from the computer and the modem.

- 7 Disconnect the AC adapter cable from your wireless router to ensure that there is no power connected to the router.



**NOTE:** Wait for a minimum of 5 minutes after disconnecting your broadband modem before you continue with the network setup.

- 8 Insert a network cable into the network (RJ-45) connector on the unpowered broadband modem.
- 9 Connect the other end of the network cable into the Internet network (RJ-45) connector on the unpowered wireless router.
- 10 Ensure that no network or USB cables, other than the network cable connecting the modem and the wireless router, are connected to the broadband modem.



**NOTE:** Restart your wireless equipment in the order described below to prevent a potential connection failure.

- 11 Turn on *only* your broadband modem and wait for at least 2 minutes for the broadband modem to stabilize. After 2 minutes, proceed to step 12.
- 12 Turn on your wireless router and wait for at least 2 minutes for the wireless router to stabilize. After 2 minutes, proceed to the step 13.
- 13 Start your computer and wait until the boot process completes.
- 14 See the documentation that came with your wireless router to do the following in order to set up the wireless router:
  - Establish communication between your computer and your wireless router.
  - Configure your wireless router to communicate with your broadband router.
  - Find out your wireless router's broadcast name. The technical term for the name of your router's broadcast name is Service Set Identifier (SSID) or network name.
- 15 If necessary, configure your wireless network card to connect to the wireless network (see "Connecting to a WLAN" on page 79).

## Connecting to a WLAN



**NOTE:** Before you connect to a WLAN, ensure that you have followed the instructions in "Wireless Local Area Network (WLAN)" on page 77.



**NOTE:** The following networking instructions do not apply to internal cards with Bluetooth® wireless technology or cellular products.

This section provides general procedures for connecting to a network using wireless technology. Specific network names and configuration details vary. See "Wireless Local Area Network (WLAN)" on page 77 for more information about how to prepare for connecting your computer to a WLAN.

Your wireless network card requires specific software and drivers for connecting to a network. The software is already installed.



**NOTE:** If the software is removed or corrupted, follow the instructions in the user documentation for your wireless network card. Verify the type of wireless network card installed in your computer and then search for that name on the Dell™ Support website at [support.dell.com](http://support.dell.com). For information on the type of wireless network card that is installed in your computer, see "Checking Your Wireless Network Card" on page 77.

### Determining the Wireless Network Device Manager

Depending on the software installed on your computer, different wireless configuration utilities may manage your network devices:

- Your wireless network card's client utility
- The Windows XP or Windows Vista operating system

To determine which wireless configuration utility is managing your wireless network card in Windows XP:

- 1 Click **Start** → **Settings** → **Control Panel** → **Network Connections**.
- 2 Right-click the **Wireless Network Connection** icon, and then click **View Available Wireless Networks**.

If the **Choose a wireless network** window states **Windows cannot configure this connection**, the wireless network card's client utility is managing the wireless network card.

If the **Choose a wireless network** window states **Click an item in the list below to connect to a wireless network in range or to get more information**, the Windows XP operating system is managing the wireless network card.

To determine which wireless configuration utility is managing your wireless network card in Windows Vista:

- 1 Click  → **Connect To** → **Manage wireless networks**.
- 2 Double-click a profile to open the wireless network properties screen.

For specific information about the wireless configuration utility installed on your computer, see your wireless network documentation in the Windows Help and Support Center (see "Windows Help and Support Center" on page 17).

### **Completing the Connection to the WLAN**

When you turn on your computer and a network (for which your computer is not configured) is detected in the area, a pop-up appears near the network icon in the notification area (in the lower-right corner of the Windows desktop).

Follow the instructions provided in any utility prompts that appear on your screen.

Once you have configured your computer for the wireless network that you selected, another pop-up notifies you that your computer is connected to that network.

Thereafter, whenever you log on to your computer within the range of the wireless network that you selected, the same pop-up notifies you of the wireless network connection.



**NOTE:** If you select a secure network, you must enter a WEP or WPA key when prompted. Network security settings are unique to your network. Dell cannot provide this information.



**NOTE:** Your computer can take up to 1 minute to connect to the network.

### **Enabling/Disabling the Wireless Network Card**



**NOTE:** If you are unable to connect to a wireless network, ensure that you have all the components for establishing a WLAN (see "What You Need to Establish a WLAN Connection" on page 77), and then verify that your wireless network card is enabled by pressing <Fn><F2>.

You can turn your computer's wireless networking function on and off by pressing the <Fn><F2> key combination.

## Monitoring the Status of the Wireless Network Card Through Dell QuickSet

The wireless activity indicator provides you with an easy way to monitor the status of your computer's wireless devices. To turn the wireless activity indicator on or off, click the QuickSet icon in the taskbar and select **Hotkey Popups**. If **Wireless Activity Indicator Off** is not checked, the indicator is on. If **Wireless Activity Indicator Off** is checked, the indicator is off.

The wireless activity indicator displays whether your computer's integrated wireless devices are enabled or disabled. When you turn the wireless networking function on or off, the wireless activity indicator changes to display the status.

For more information about the Dell QuickSet wireless activity indicator, right-click the QuickSet icon in the taskbar and select **Help**.

## Mobile Broadband/Wireless Wide Area Network (WWAN)

A Mobile Broadband network, also known as a Wireless Wide Area Network (WWAN), is a high-speed digital cellular network that provides Internet access over a much wider geographical area than a WLAN, which typically covers only from 100 to 1000 feet. Your computer can maintain Mobile Broadband network access as long as the computer is within a cellular-data coverage zone. Contact your service provider for coverage of a high-speed digital cellular network.



**NOTE:** Even if you are able to make a call from your cellular phone in a specific geographical location, that location may not necessarily be within a cellular-data coverage zone.

## What You Need to Establish a Mobile Broadband Network Connection



**NOTE:** Depending on your computer, you can use either a Mobile Broadband ExpressCard or Mini-Card, but not both, to establish a Mobile Broadband network connection.

To set up a Mobile Broadband network connection, you need:

- A Mobile Broadband ExpressCard or Mini-Card (depending on your computer's configuration)



**NOTE:** For instructions on using ExpressCards, see "Using Cards" on page 69

- An activated Mobile Broadband ExpressCard or activated Subscriber Identity Module (SIM) for your service provider

- The Dell Mobile Broadband Card Utility (already installed on your computer if you purchased the card when you purchased your computer, or on the CD that accompanied your card if purchased separately from your computer)

If the utility is corrupted or deleted from your computer, see the Dell Mobile Broadband Card Utility user's guide for instructions. The user's guide is available through the Windows Help and Support Center (see "Windows Help and Support Center" on page 17) or on the CD that accompanied your card if you purchased it separately from your computer.

## Checking Your Dell Mobile Broadband Card

Depending on what you selected when you purchased your computer, the computer has a variety of configurations. To determine your computer configuration, see one of the following:

- Your order confirmation
- Microsoft Windows Help and Support Center

To check your Mobile Broadband card in the Windows Help and Support Center:

- 1 Click **Start**→ **Help and Support**→ **Use Tools to view your computer information and diagnose problems**. Under **Tools**, click **My Computer Information**→ **Find information about the hardware installed on this computer**.

On the **My Computer Information - Hardware** screen, you can view the type of Mobile Broadband card installed in your computer as well as other hardware components.



The Mobile Broadband card is listed under **Modems**.

## Microsoft® Windows® Firewall

Windows Firewall provides basic protection from unauthorized access to your computer while it is connected to the Internet. Windows Firewall is automatically enabled when you run the Network Setup Wizard.

When Windows Firewall is enabled for a network connection, the firewall icon appears with a red background in the **Network Connections** section of the Control Panel.



**NOTE:** Enabling Windows Firewall does not reduce the need for virus-checking software.

For more information, click **Start**→ **Control Panel**→ **Security**→ **Windows Firewall**, or see "Windows Help and Support Center" on page 17.



# Securing Your Computer

## Security Cable Lock

 **NOTE:** Your computer does not ship with a security cable lock.

A security cable lock is a commercially available antitheft device. To use the lock, attach it to the security cable slot on your computer. For more information, see the instructions included with the device.

 **NOTICE:** Before you buy an antitheft device, ensure that it will work with the security cable slot on your computer.



## Passwords

Passwords prevent unauthorized access to your computer. When you first start your computer, you must assign a primary password at the prompt. If you do not enter a password within 2 minutes, the computer returns to its previous operating state.

When using passwords, observe the following guidelines:

- Choose a password that you can remember, but not one that is easy to guess. For example, do not use the names of family members or pets for passwords.
- It is recommended that you do not write down your password. If you do write it down, however, ensure that the password is stored in a secure place.
- Do not share your password with other people.
- Ensure that people are not watching you when you type your password.



**NOTICE:** Passwords provide a high level of security for data in your computer or hard drive. However, they are not foolproof. If you require more security, obtain and use additional forms of protection, such as smart cards, data encryption programs, or ExpressCards (or Mini-Cards) with encryption features.

To add or change passwords, access **User Accounts** from the Control Panel.

If you forget any of your passwords, contact Dell (see "Contacting Dell" on page 165). For your protection, Dell technical support staff will ask you for proof of your identity to ensure that only an authorized person can use the computer.

## Computer Tracking Software

Computer tracking software may enable you to locate your computer if it is lost or stolen. The software is optional and may be purchased when you order your computer, or you can contact your sales representative for information about this security feature.



**NOTE:** Computer tracking software may not be available in certain countries.



**NOTE:** If you have computer tracking software and your computer is lost or stolen, you must contact the company that provides the tracking service to report the missing computer.

## If Your Computer Is Lost or Stolen

- Call a law enforcement agency to report the lost or stolen computer. Include the Service Tag in your description of the computer. Ask that a case number be assigned and write down the number, along with the name, address, and phone number of the law enforcement agency. If possible, obtain the name of the investigating officer.



**NOTE:** If you know where the computer was lost or stolen, call a law enforcement agency in that area. If you do not know, call a law enforcement agency where you live.

- If the computer belongs to a company, notify the security office of the company.
- Contact Dell customer service to report the missing computer. Provide the computer Service Tag, the case number, and the name, address, and phone number of the law enforcement agency to which you reported the missing computer. If possible, give the name of the investigating officer.

The Dell customer service representative will log your report under the computer Service Tag and record the computer as missing or stolen. If someone calls Dell for technical assistance and gives your Service Tag, the computer is identified automatically as missing or stolen. The representative will attempt to get the phone number and address of the caller. Dell will then contact the law enforcement agency to which you reported the missing computer.



# Adding and Replacing Parts

## Before You Begin

This chapter provides procedures for removing and installing the components in your computer. Unless otherwise noted, each procedure assumes that the following conditions exist:

- You have performed the steps in "Turning Off Your Computer" (see "Turning Off Your Computer" on page 89) and "Before Working Inside Your Computer" (see "Before Working Inside Your Computer" on page 90).
- You have read the safety information in your Dell™ *Product Information Guide*.
- A component can be replaced or—if purchased separately—installed by performing the removal procedure in reverse order.

## Recommended Tools

The procedures in this document may require the following tools:

- Small flat-blade screwdriver
- Phillips screwdriver
- Small plastic scribe
- Flash BIOS update (see the Dell Support website at [support.dell.com](http://support.dell.com))

## Turning Off Your Computer



**NOTICE:** To avoid losing data, save and close any open files and exit any open programs before you turn off your computer.

- 1 Shut down the operating system:
  - a Save and close any open files, exit any open programs, click the **Start** button, and then click **Turn Off Computer**.
  - b In the **Turn off computer** window, click **Turn off**.

The computer turns off after the operating system shutdown process finishes.

- 2 Ensure that the computer and any attached devices are turned off. If your computer and attached devices did not automatically turn off when you shut down your operating system, press and hold the power button for several seconds until the computer turns off.

## Before Working Inside Your Computer

Use the following safety guidelines to help protect your computer from potential damage and to help ensure your own personal safety.



**CAUTION:** Before you begin any of the procedures in this section, follow the safety instructions in the *Product Information Guide*.



**CAUTION:** Handle components and cards with care. Do not touch the components or contacts on a card. Hold a card by its edges or by its metal mounting bracket. Hold a component such as a processor by its edges, not by its pins.



**NOTICE:** Only a certified service technician should perform repairs on your computer. Damage due to servicing that is not authorized by Dell is not covered by your warranty.



**NOTICE:** When you disconnect a cable, pull on its connector or on its strain-relief loop, not on the cable itself. Some cables have a connector with locking tabs; if you are disconnecting this type of cable, press in on the locking tabs before you disconnect the cable. As you pull connectors apart, keep them evenly aligned to avoid bending any connector pins. Also, before you connect a cable, ensure that both connectors are correctly oriented and aligned.



**NOTICE:** To help prevent damage to the computer, perform the following steps before you begin working inside the computer.

- 1 Ensure that the work surface is flat and clean to prevent the computer cover from being scratched.
- 2 Turn off your computer. See "Turning Off Your Computer" on page 89.



**NOTICE:** To disconnect a network cable, first unplug the cable from your computer and then unplug it from the network wall jack.

- 3 Disconnect any telephone or network cables from the computer.



**NOTICE:** To help prevent damage to the system board, you must remove the battery from the battery bay before you service the computer.



**NOTE:** To avoid damage to the computer, use only the battery designed for this particular Dell computer. Do not use other batteries designed for other Dell computers.

- 4 Disconnect your computer and all attached devices from their electrical outlets, slide and hold the battery-bay latch release on the bottom of the computer, and then lift the battery from the bay.

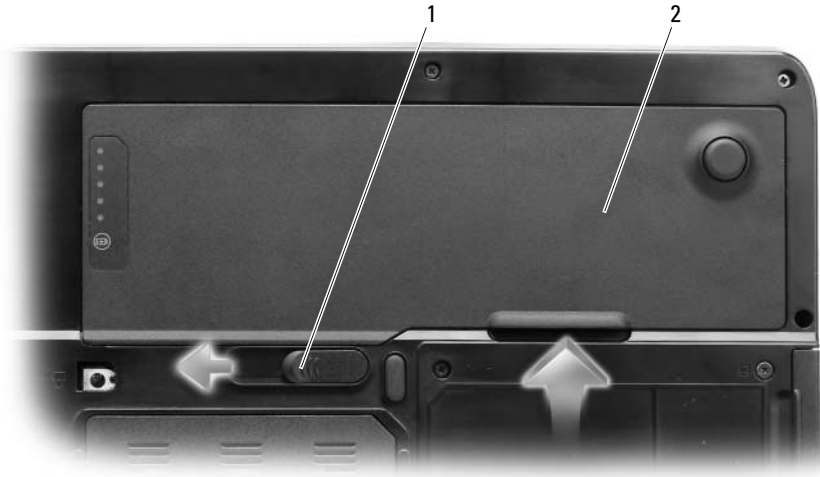

1 battery-bay latch release      2 battery

- 5 Press the power button to ground the system board.
- 6 Remove any installed cards from the ExpressCard slot (see "Removing an ExpressCard or Blank" on page 71) and the 3-in-1 media memory card reader (see "Removing a Media Memory Card" on page 73).
- 7 Close the display and turn the computer upside down on a flat work surface.
- 8 Remove the hard drive (see "Hard Drive" on page 92).

## Optical Drive

**⚠ CAUTION:** Before you begin any of the procedures in this section, follow the safety instructions in the *Product Information Guide*.

- 1 Turn the computer off.
- 2 Turn the computer over and remove the device security screw.
- 3 Insert a scribe into the notch and push it to the side to release the drive from the bay.
- 4 Slide the drive out of the bay.

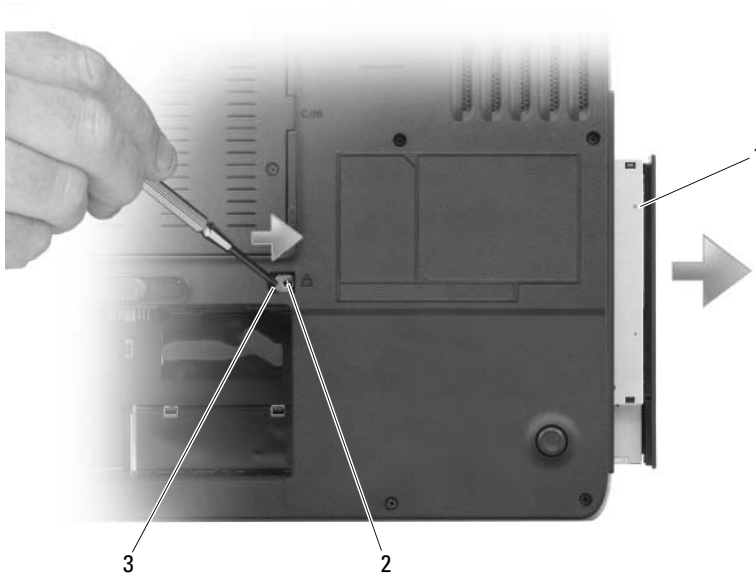

1 optical drive      2 device security screw      3 notch

## Hard Drive

**⚠ CAUTION:** If you remove the hard drive from the computer when the drive is hot, *do not touch* the metal housing of the hard drive.

**⚠ CAUTION:** Before you begin any of the procedures in this section, follow the safety instructions in the *Product Information Guide*.



- ➔ **NOTICE:** To prevent data loss, turn off your computer (see "Turning Off Your Computer" on page 89) before removing the hard drive. Do not remove the hard drive while the computer is on, in standby mode, or in hibernate mode.
- ➔ **NOTICE:** Hard drives are extremely fragile; even a slight bump can damage the drive.
- 📎 **NOTE:** Dell does not guarantee compatibility or provide support for hard drives from sources other than Dell.
- 📎 **NOTE:** If you are installing a hard drive from a source other than Dell, you need to install an operating system, drivers, and utilities on the hard drive. See "Restoring Your Microsoft® Windows Vista® Operating System" on page 148 and "Reinstalling Drivers and Utilities" on page 144.

To replace the hard drive in the hard drive bay:

- 1 Follow the procedures in "Before You Begin" on page 89.
- 2 Turn the computer over, and remove the hard drive screws.

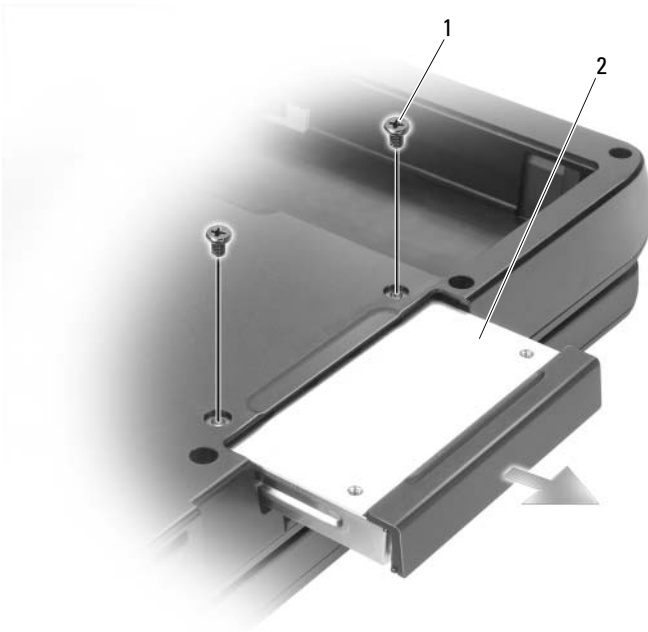

1 hard drive screws (2)

2 hard drive

➔ **NOTICE:** When the hard drive is not in the computer, store it in protective antistatic packaging. See "Protecting Against Electrostatic Discharge" in the *Product Information Guide*.

3 Slide the hard drive out of the computer.

4 Remove the new drive from its packaging.

Save the original packaging for storing or shipping the hard drive.

➔ **NOTICE:** Use firm and even pressure to slide the drive into place. If you use excessive force, you may damage the connector.

5 Slide the hard drive into the bay until it is fully seated.

6 Replace and tighten the hard drive screws.

7 Install the operating system for your computer. See "Restoring Your Microsoft® Windows Vista® Operating System" on page 148.

8 Install the drivers and utilities for your computer. See "Reinstalling Drivers and Utilities" on page 144.

## Returning a Hard Drive to Dell

Return your old hard drive to Dell in its original or comparable foam packaging. Otherwise, the hard drive may be damaged in transit.

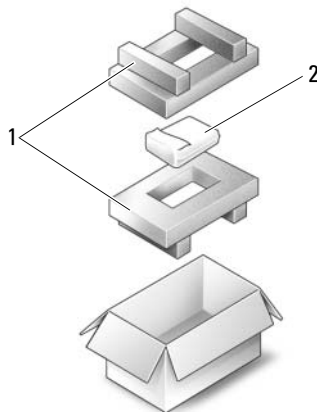

1 foam packaging

2 hard drive

# Memory

 **CAUTION:** Before you begin any of the procedures in this section, follow the safety instructions in the *Product Information Guide*.

You can increase your computer memory by installing memory modules on the system board. See "Specifications" on page 167 for information on the memory supported by your computer. Install only memory modules that are intended for your computer.

 **NOTE:** Memory modules purchased from Dell are covered under your computer warranty.

- 1 Follow the procedures in "Before You Begin" on page 89.
- 2 Turn the computer over, loosen the captive screws on the memory module cover, and then remove the memory module cover.

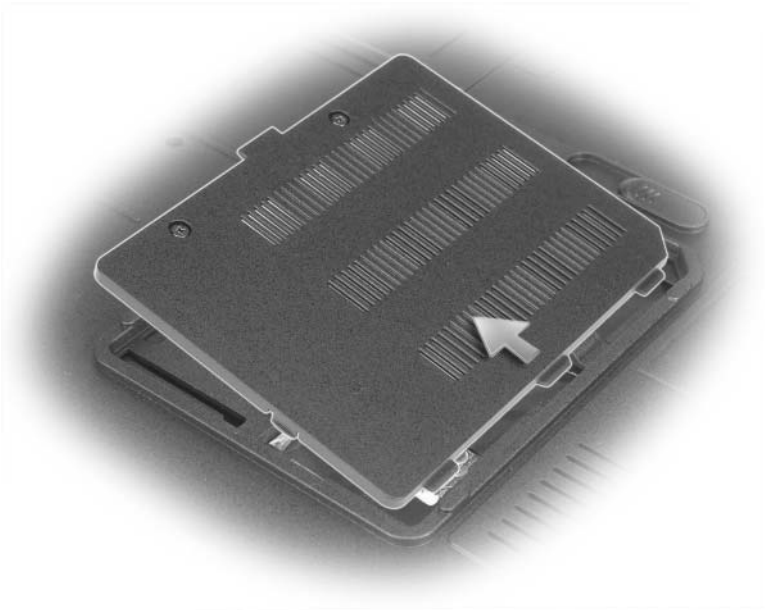

 **NOTICE:** To prevent damage to the memory module connector, do not use tools to spread the memory-module securing clips.

**➔ NOTICE:** To avoid electrostatic discharge, ground yourself by using a wrist grounding strap or by periodically touching an unpainted metal surface (such as a connector on the back of the computer).

- 3 If you are replacing a memory module, remove the existing module:
  - a Use your fingertips to carefully spread apart the memory-module securing clips on each end of the memory module connector until the module pops up.
  - b Remove the module from the connector.

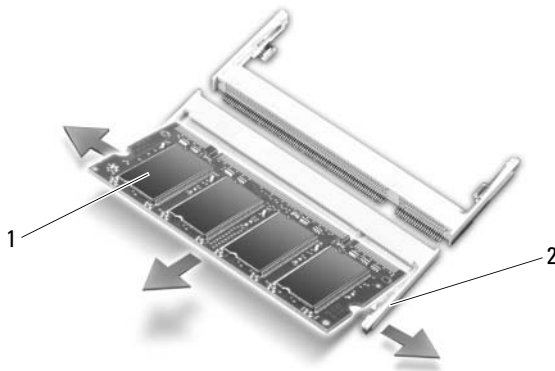

1 memory module

2 memory-module securing clips (2 per connector)

**🔪 NOTICE:** If the memory module is not installed properly, the computer may not boot properly. No error message indicates this failure.

- 4 Ground yourself and install the new memory module:
  - a Align the notch in the module edge connector with the tab in the connector slot.
  - b Slide the module firmly into the slot at a 45-degree angle, and rotate the module down until it clicks into place. If you do not feel the click, remove the module and reinstall it.

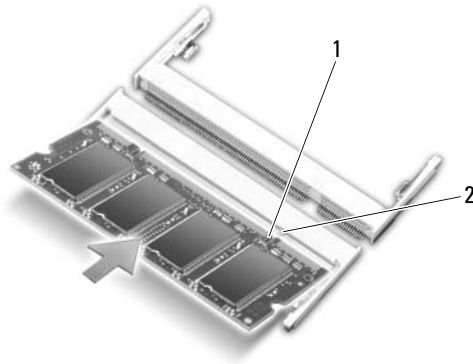

1 notch

2 tab

➔ **NOTICE:** If the memory module cover is difficult to close, remove the module and reinstall it. Forcing the cover to close may damage your computer.

- 5 Replace the memory module cover.
- 6 Insert the battery into the battery bay, or connect the AC adapter to your computer and an electrical outlet.
- 7 Reinstall the hard drive. See "Hard Drive" on page 92.
- 8 Turn on the computer.

As the computer boots, it detects the additional memory and automatically updates the system configuration information.

To confirm the amount of memory installed in the computer:

- In the *Microsoft® Windows® XP operating system*, right-click the My Computer icon on your desktop. Click **Properties**→**General**.
- In the *Microsoft Windows Vista® operating system*, click the Windows Vista Start button , and right-click **Computer**→**Properties**.

# Modem

**⚠ CAUTION:** Before you begin any of the procedures in this section, follow the safety instructions in the *Product Information Guide*.

If you ordered the optional modem at the same time that you ordered your computer, the modem is already installed.

- 1 Follow the procedures in "Before You Begin" on page 89.
- 2 Turn the computer over, loosen the captive screws on the modem cover, and then remove the modem cover.

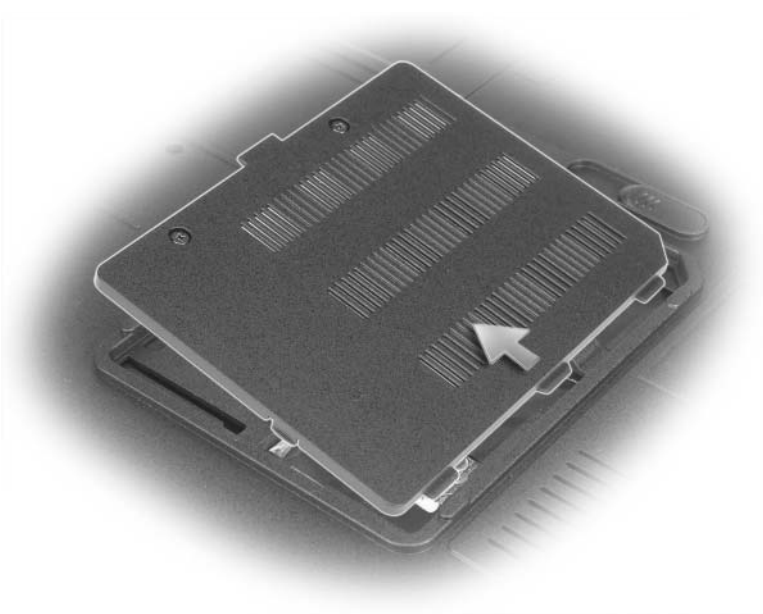

- 3 Remove the existing modem:
  - a Remove the modem screw.
  - b Pull straight up on the attached pull-tab to lift the modem out of its connector on the system board, and disconnect the modem cable.

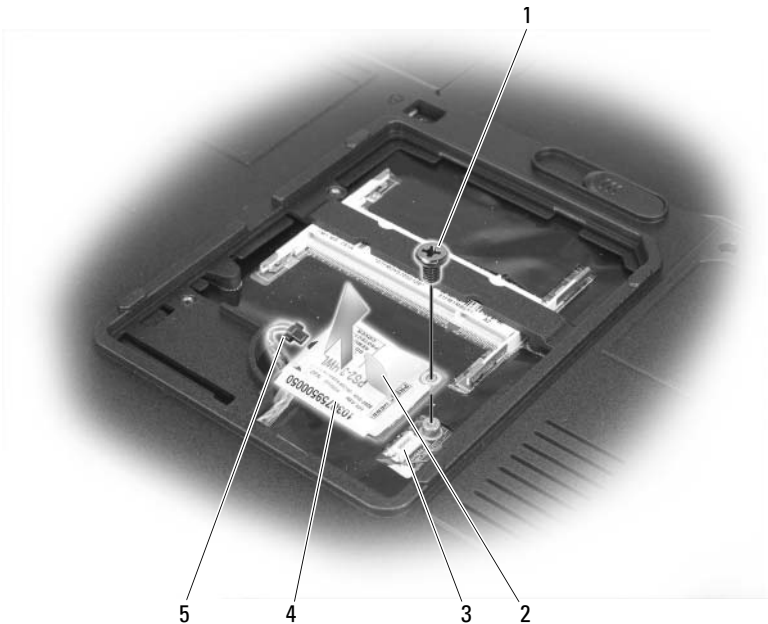

- |   |             |   |                |   |                                 |
|---|-------------|---|----------------|---|---------------------------------|
| 1 | modem screw | 2 | modem pull-tab | 3 | modem connector on system board |
| 4 | modem       | 5 | modem cable    |   |                                 |

**4** Install the replacement modem:

- a** Connect the modem cable to the modem.

**➔ NOTICE:** The connector is keyed to ensure correct insertion. If you feel resistance, check the connector and realign the card.

- b** Align the modem with the screw holes and press the modem down into the connector on the system board.

- c** Replace the screw that secures the modem to the system board.

**5** Replace the modem cover.

# Hinge Cover



**CAUTION:** Before you begin any of the procedures in this section, follow the safety instructions in the *Product Information Guide*.



**NOTICE:** To avoid electrostatic discharge, ground yourself by using a wrist grounding strap or by periodically touching an unpainted metal surface (such as a connector on the back of the computer).



**NOTICE:** To help prevent damage to the system board, you must remove the battery from the battery bay before you begin working inside the computer.

1 Follow the procedures in "Before You Begin" on page 89.

2 Remove the hinge cover:

a Open the display all the way (180 degrees) so that it lies flat against your work surface.



**NOTICE:** To avoid damage to the hinge cover, do not lift the cover on both sides simultaneously.

b Insert a scribe into the indent to lift the hinge cover on the right side.

c Ease the hinge cover up, moving from right to left, and remove it.



**NOTE:** When replacing the hinge cover, first insert the left edge and then press from left to right until the cover snaps into place.



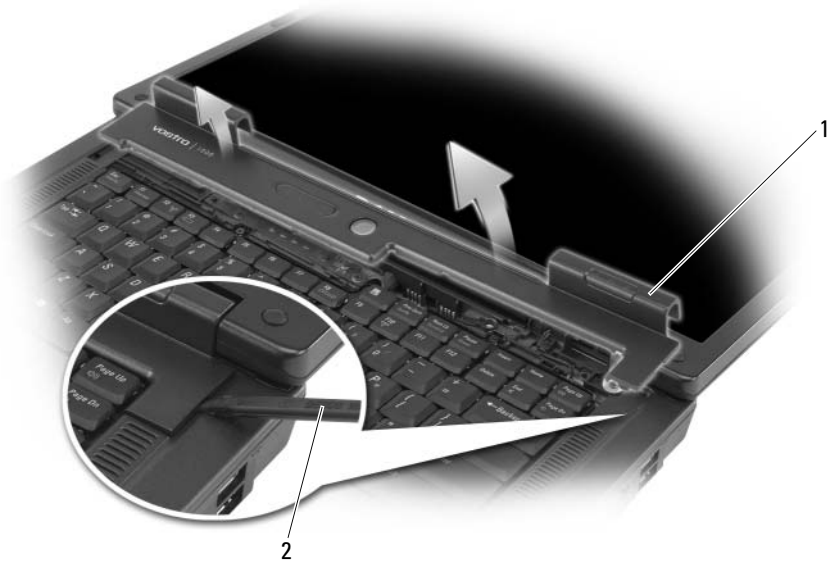

1 hinge cover

2 scribe

## Keyboard

**⚠ CAUTION:** Before you begin any of the procedures in this section, follow the safety instructions in the *Product Information Guide*.

**➡ NOTICE:** To avoid electrostatic discharge, ground yourself by using a wrist grounding strap or by periodically touching an unpainted metal surface (such as a connector on the back of the computer).

**➡ NOTICE:** To help prevent damage to the system board, you must remove the battery from the battery bay before you begin working inside the computer.

- 1 Follow the procedures in "Before You Begin" on page 89.
- 2 Open the display.
- 3 Remove the hinge cover. See "Hinge Cover" on page 100.

**4** Remove the keyboard:

- a** Remove the two keyboard screws.

**➔ NOTICE:** The keycaps on the keyboard are fragile, easily dislodged, and time-consuming to replace. Be careful when removing and handling the keyboard.

- b** Slightly slide the keyboard toward the back of the computer, and then lift the keyboard only enough to hold it up and slightly forward to allow access to the keyboard connector.

- c** To release the keyboard cable from the keyboard connector on the system board, rotate the plastic bar on the keyboard connector to the front of the computer.

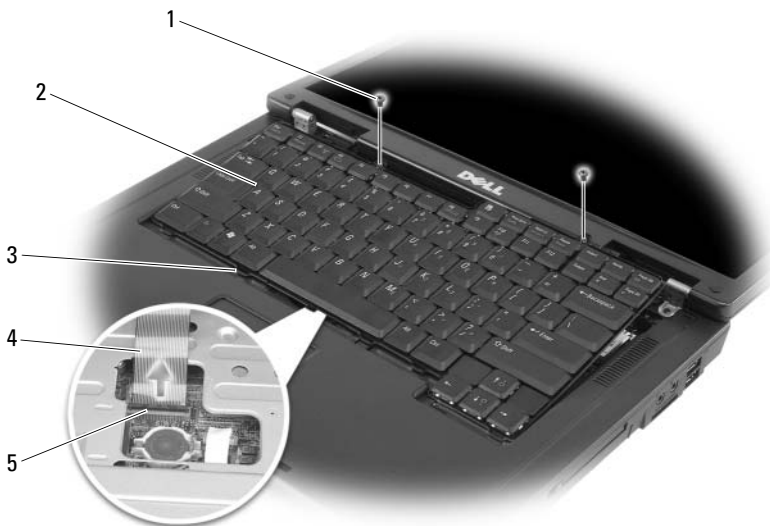

- |   |                     |   |                                   |   |      |
|---|---------------------|---|-----------------------------------|---|------|
| 1 | keyboard screws (2) | 2 | keyboard                          | 3 | tabs |
| 4 | keyboard cable      | 5 | plastic bar on keyboard connector |   |      |

**➔ NOTICE:** To avoid scratching the palm rest when replacing the keyboard, hook the tabs along the front edge of the keyboard into the palm rest, and then press on the right edge near the top to snap the keyboard into place before replacing the two screws.

# Wireless Mini-Card

If you ordered a Mini-Card with your computer, the card is already installed.

**⚠ CAUTION:** Before you begin any of the procedures in this section, follow the safety instructions in the *Product Information Guide*.

**➡ NOTICE:** To help prevent damage to the system board, you must remove the battery from the battery bay before you begin working inside the computer.

- 1 Follow the procedures in "Before You Begin" on page 89.
- 2 Remove the hinge cover. See "Hinge Cover" on page 100.
- 3 Remove the keyboard. See "Keyboard" on page 101.
- 4 If a Mini-Card is not already installed, go to step 5. If you are replacing a Mini-Card, remove the existing card:
  - a Disconnect the two antenna cables from the Mini-Card.



1 Mini-Card

2 antenna cable connectors (2)

- b Release the Mini-Card by pushing the metal securing tabs toward the back of the computer until the card pops up slightly.
- c Lift the Mini-Card out of its system board connector.

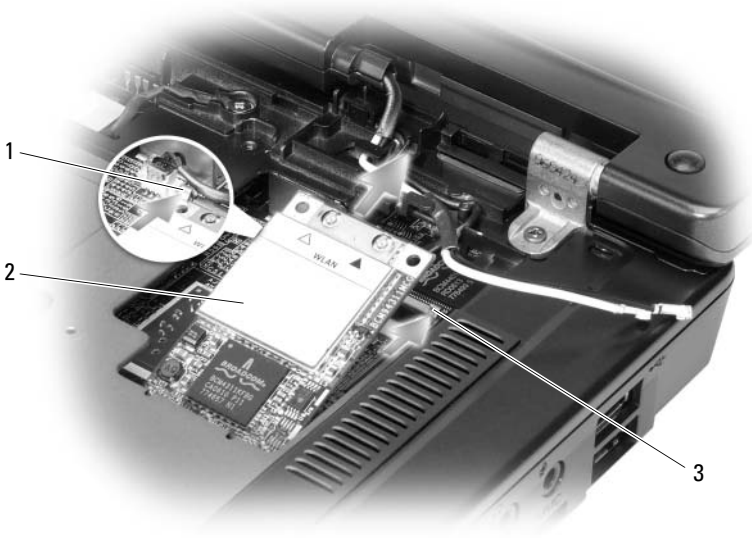

1 metal securing tab      2 Mini-Card      3 metal securing tab

**➔ NOTICE:** The connectors are keyed to ensure correct insertion. If you feel resistance, check the connectors on the card and on the system board, and realign the card.

- 5 Install the replacement Mini-Card:
  - a Insert the Mini-Card connector into the system board connector at a 45-degree angle, and then press the other end of the Mini-Card down into the securing tabs until the card clicks into place.



➔ **NOTICE:** To avoid damage to the Mini-Card, never place cables under the card.

- b** Connect the two antenna cables to the Mini-Card (black cable to the connector labeled "aux" and the white cable to the connector labeled "main").



1 system board connector

2 antenna cables (2)

3 antenna cable connectors (2)

## Coin-Cell Battery

**⚠ CAUTION:** Before you begin any of the procedures in this section, follow the safety instructions in the *Product Information Guide*.

**➡ NOTICE:** To avoid electrostatic discharge, ground yourself by using a wrist grounding strap or by periodically touching an unpainted metal surface (such as a connector on the back of the computer).

**➡ NOTICE:** To help prevent damage to the system board, you must remove the battery from the battery bay before you begin working inside the computer.

- 1 Follow the procedures in "Before You Begin" on page 89.
- 2 Remove the hinge cover. See "Hinge Cover" on page 100.
- 3 Remove the keyboard. See "Keyboard" on page 101.

- 4 Insert a plastic scribe into the guide on the side of the coin-cell battery compartment, and pop the battery out.

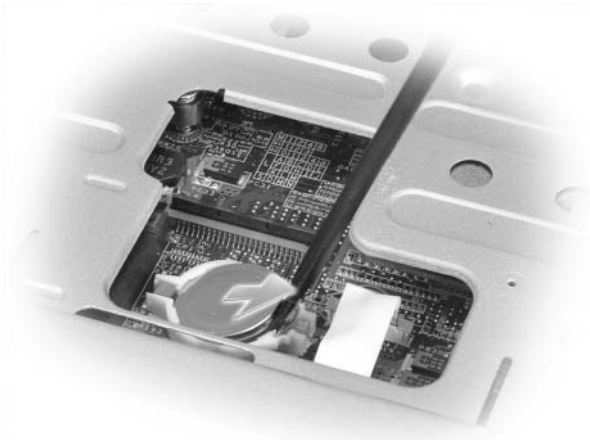

When you replace the battery, insert it at a 30-degree angle under the clip with the positive (identified by a plus [+ ] symbol) side up, and then push it into place.

## Display



**CAUTION:** Before you begin any of the procedures in this section, follow the safety instructions in the *Product Information Guide*.



**NOTICE:** To avoid electrostatic discharge, ground yourself by using a wrist grounding strap or by periodically touching an unpainted metal surface (such as a connector on the back of the computer).



**NOTICE:** To help prevent damage to the system board, you must remove the battery from the battery bay before you begin working inside the computer.

- 1 Follow the procedures in "Before You Begin" on page 89.
- 2 Remove the hinge cover. See "Hinge Cover" on page 100.
- 3 Remove the six screws that secure the display (two on the top, two on the bottom, and two on the back).
- 4 Disconnect the antenna cables from the Mini-Card.

- 5 Loosen the captive grounding-wire screw.
- 6 Disconnect the display cable, using the pull-tab.
- 7 Dislodge the display cable from the display cable channel.

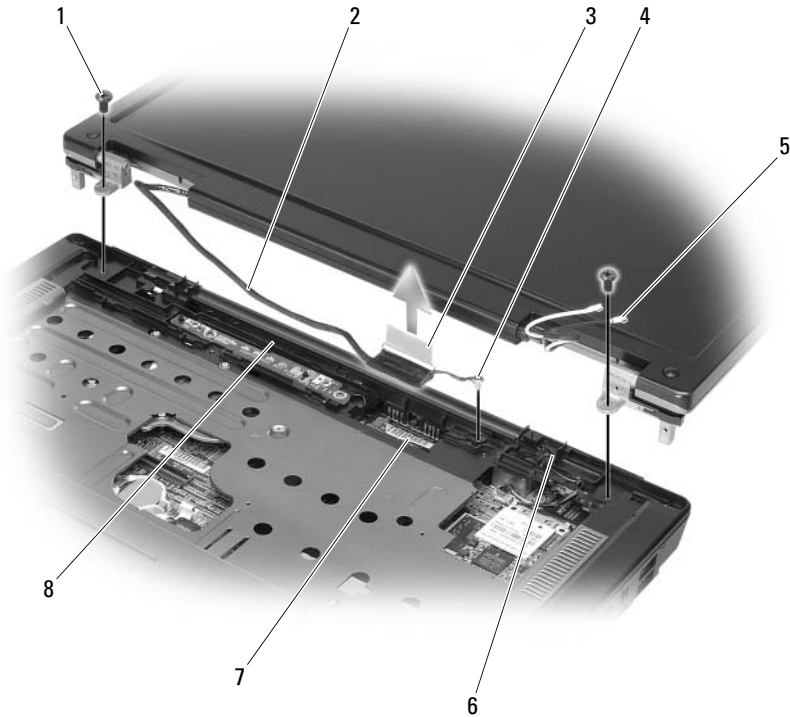

- |   |                         |                          |
|---|-------------------------|--------------------------|
| 1 screws (2)                              | 2 display cable         | 3 display cable pull-tab |
| 4 captive grounding-wire screw            | 5 antenna cables (2)    | 6 standby switch         |
| 7 display cable connector on system board | 8 display cable channel |                          |

- 8 Lift the display away from the computer.

**➔ NOTICE:** The standby switch is fragile and easily broken. Avoid knocking the switch when removing and replacing the display.



When you replace the display, ensure that the display cable is lying flat in the display cable channel and securely tucked underneath the tabs.

Also, ensure that the antenna cables are not twisted and that they are lying flat in the antenna cable clip.



# Troubleshooting

## Dell Technical Update Service

The Dell Technical Update service provides proactive e-mail notification of software and hardware updates for your computer. The service is free and can be customized for content, format, and how frequently you receive notifications.

To enroll for the Dell Technical Update service, go to [support.dell.com/technicalupdate](http://support.dell.com/technicalupdate).

## Dell Diagnostics



**CAUTION:** Before you begin any of the procedures in this section, follow the safety instructions in the *Product Information Guide*.

### When to Use the Dell Diagnostics

If you experience a problem with your computer, perform the checks in "Lockups and Software Problems" on page 130 and run the Dell Diagnostics before you contact Dell for technical assistance.

It is recommended that you print these procedures before you begin.



**NOTE:** The Dell Diagnostics only operates on Dell computers.

Enter the system setup program, review your computer's configuration information, and ensure that the device you want to test displays in the system setup program and is active (see "Using the System Setup Program" on page 175).

Start the Dell Diagnostics from your hard drive or from your *Drivers and Utilities* media (see "Drivers and Utilities Media" on page 13).

### Starting the Dell Diagnostics From Your Hard Drive

The Dell Diagnostics is located on a hidden diagnostic utility partition on your hard drive.

 **NOTE:** If your computer cannot display a screen image, see "Contacting Dell" on page 165.

- 1 Ensure that the computer is connected to an electrical outlet that is known to be working properly.
- 2 Turn on (or restart) your computer.
- 3 Start the Dell Diagnostics in one of the following two ways.

 **NOTE:** If you wait too long and the operating system logo appears, continue to wait until you see the Microsoft® Windows® desktop; then, shut down your computer and try again.

- When the DELL™ logo appears, press <F12> immediately. Select **Diagnostics** from the boot menu and press <Enter>.

 **NOTE:** Before attempting the following option, the computer must be powered down completely.

- Press and hold the <Fn> key while powering the computer on.

 **NOTE:** If you see a message stating that no diagnostics utility partition has been found, run the Dell Diagnostics from the *Drivers and Utilities* media.

The computer runs the Pre-boot System Assessment (PSA), a series of initial tests of your system board, keyboard, display, memory, and hard drive.

- During the assessment, answer any questions that appear.
- If failures are detected, the computer stops and beeps. To stop the assessment and restart the computer, press <n>; to continue to the next test, press <y>; to retest the component that failed, press <r>.
- If failures are detected during the Pre-boot System Assessment, write down the error codes and contact Dell (see "Contacting Dell" on page 165).

If the Pre-boot System Assessment completes successfully, you receive the message **Booting Dell Diagnostic Utility Partition**. Press any key to continue.

- 4 Press any key to start the Dell Diagnostics from the diagnostics utility partition on your hard drive.

## Starting the Dell Diagnostics From the Drivers and Utilities Media

- 1 Insert your *Drivers and Utilities* media.
- 2 Shut down and restart the computer.

When the DELL logo appears, press <F12> immediately.



**NOTE:** If you wait too long and the operating system logo appears, continue to wait until you see the Microsoft® Windows® desktop; then, shut down your computer and try again.



**NOTE:** The next steps change the boot sequence for one time only. On the next start-up, the computer boots according to the devices specified in the system setup program.



**NOTE:** Keyboard failure may result when a key on the keyboard is held down for extended periods of time. To avoid possible keyboard failure, press and release the <F12> key in even intervals until the boot device menu appears.

- 3 At the boot device menu, use the up- and down-arrow keys to highlight CD/DVD/CD-RW, and then press <Enter>.



**NOTE:** The Quickboot feature changes the boot sequence for the current boot only. Upon restart, the computer boots according to the boot sequence specified in the system setup program.

- 4 Select the **Boot from CD-ROM** option from the menu that appears and then press <Enter>.
- 5 Type 1 to start the *Drivers and Utilities* menu and then press <Enter>.
- 6 Select **Run the 32 Bit Dell Diagnostics** from the numbered list. If multiple versions are listed, select the version appropriate for your computer.
- 7 At the Dell Diagnostics **Main Menu**, select the test you want to run.



**NOTE:** Write down any error codes and problem descriptions exactly as they appear and follow the instructions on the screen.

- 8 After all tests have completed, close the test window to return to the Dell Diagnostics **Main Menu**.
- 9 Remove your *Drivers and Utilities* media and then close the **Main Menu** window to exit the Dell Diagnostics and restart the computer.

## Dell Diagnostics Main Menu

After the Dell Diagnostics loads and the **Main Menu** screen appears, click the button for the option you want.



**NOTE:** It is recommended that you select **Test System** to run a complete test on your computer.

Option	Function
Test Memory	Run the stand-alone memory test
Test System	Run System Diagnostics
Exit	Exit the Diagnostics

After you have selected the **Test System** option from the main menu, the following menu appears.



**NOTE:** It is recommended that you select **Extended Test** from the menu to run a more thorough check of the devices in the computer.

Option	Function
Express Test	Performs a quick test of system devices. The test typically takes 10 to 20 minutes and requires no interaction on your part. Run Express Test first to increase the possibility of tracing the problem quickly.
Extended Test	Performs a thorough check of system devices. The test typically takes an hour or more and periodically requires your input to answer specific questions.
Custom Test	Tests a specific device in the system and can be used to customize the tests you want to run.
Symptom Tree	Lists a number of common symptoms and allows you to select a test based on the symptom of the problem you are having.

For any problem encountered during a test, a message appears with an error code and a description of the problem. Write down the error code and problem description exactly as it appears and follow the instructions on the screen. If you cannot resolve the problem, contact Dell (see "Contacting Dell" on page 165).



**NOTE:** The Service Tag for your computer is located at the top of each test screen. When contacting Dell support, have your Service Tag ready.

The following tabs provide additional information for tests run from the **Custom Test** or **Symptom Tree** option:

<b>Tab</b>	<b>Function</b>
Results	Displays the results of the test and any error conditions encountered.
Errors	Displays error conditions encountered, error codes, and the problem description.
Help	Describes the test and any requirements for running the test.
Configuration	Displays your hardware configuration for the selected device.  The Dell Diagnostics obtains configuration information for all devices from the system setup program, memory, and various internal tests, and it displays the information in the device list in the left pane of the screen. The device list may not display the names of all the components installed on your computer or all devices attached to your computer.
Parameters	Allows you to customize the test by changing the test settings.

# Dell Support Center

The Dell Support Center provides service, support, and system-specific information. For more information about Dell Support Center and available support tools, click the **Services** tab at [support.dell.com](http://support.dell.com).

Computers purchased on June 26, 2007 and later are pre-installed with Dell Support Center.

For computers purchased prior to June 26, 2007 you can download Dell Support Center from the **Services** page at [support.dell.com](http://support.dell.com).

Click the Dell Support Center icon  on your computer's desktop to run the application and to access the following features:

- Self-help tools such as *Dell Support*, *Dell PC TuneUp*, *Dell PC Checkup*, and *Network Assistant*
- DellConnect for remote, real-time, technical support
- Dell support contact information including e-mail and online chat addresses as well as telephone numbers
- Resources specific to your computer are available under **Drivers & Downloads**, **Upgrades** and **System Information**

The top of the Dell Support Center home page displays your computer's model number along with its Service Tag, Express Service code, and warranty expiration details. When permissions are given to Dell to use your Service Tag, additional details about your computer, such as available memory, disk space, installed hardware, network addresses, modem specifications, installed security software, and much more are provided. In addition, using your Service Tag, Dell can link you to the most relevant [www.dell.com](http://www.dell.com) web pages for information about your warranty, ordering accessories, and details about installing recommended drivers and downloads.

## Dell Support

*Dell Support* is customized for your computing environment. This utility provides self-support information, software updates, and health scans for your computer. Use this utility for following functions:

- Check your computing environment.
- View the *Dell Support* settings.
- Access the *Dell Support* help file.



- View frequently asked questions.
- Learn more about *Dell Support*.
- Turn *Dell Support* off.

For more information about *Dell Support*, click the question mark (?) at the top of the *Dell Support* window.

To access *Dell Support*:

- Click the *Dell Support* icon  in the notification area of your Windows desktop.



**NOTE:** The  icon functions vary depending on whether you click, double-click, or right-click the icon.

OR

- Click the Microsoft® Windows Vista® Start button  → **All Programs** → **Dell Support** → **Dell Support Settings**. Ensure that the **Show icon on the taskbar** option is checked.



**NOTE:** If *Dell Support* is not available from the Start menu, go to [support.dell.com](http://support.dell.com) and download the software.

## Dell PC TuneUp

The automated or monthly version of *Dell PC TuneUp* allows you to choose the day and time of the month you want your computer "tuned up." A typical tune-up includes hard drive defragmentation, removal of unwanted and temporary files, updated security settings, verification of "good" restore points, and other maintenance activities designed to improve computer performance and security. The monthly version is available as an annual subscription and is a feature of *Dell Support*, a complimentary application that provides real-time health scans and information on how to maintain your computer (see "Dell Support" on page 116).

Both versions of PC TuneUp are available to customers in the U.S. and Canada. For the latest updates and to learn how to keep your computer running at peak performance, search for the keyword *PC TuneUp* on [support.dell.com](http://support.dell.com).

## Dell PC Checkup

Dell PC Checkup is a troubleshooting and diagnostic tool that provides customized scanning and testing of your Dell computer. PC Checkup verifies whether your hardware is working properly and provides automated fixes for common configuration concerns. It is recommended that you run PC Checkup on a regular basis or before contacting Dell for assistance. The application creates a detailed report that Dell technicians can use to resolve your issue quickly.

## Dell Network Assistant

Designed specifically for users of Dell™ computers, the Dell Network Assistant helps simplify the setup, monitoring, troubleshooting, and repair of your network.

Dell Network Assistant provides the following features:

- Consolidated setup, alerting, and device status
- Simplified tracking of networked devices through a visual display of network status
- Proactive troubleshooting and repair of network problems
- Tutorials, setup wizards, and frequently asked questions (FAQs) to enhance understanding of networking principles

To access Dell Network Assistant:

- 1 Click the *Dell Support Center* icon  on your computer's desktop.
- 2 Click **Self Help**→**Network /Internet**→**Network Management**.

## DellConnect

DellConnect is a simple online access tool that allows a Dell service and support associate to access your computer through an Internet connection, diagnose the problem, and repair it. The associate works with your permission under your supervision, and you can work with Dell's associate during the troubleshooting session.

To use this service, you must have an Internet connection and your Dell computer must be under warranty. DellConnect is also available for a fee through "Dell On Call."

To begin a live session with a Dell associate:

- 1 Click the *Dell Support Center* icon  on your computer's desktop.
- 2 Click **Assistance From Dell** → **Technical Support** → **DellConnect** → **Phone** and follow the instructions.

## Drive Problems

 **CAUTION:** Before you begin any of the procedures in this section, follow the safety instructions in the *Product Information Guide*.

**ENSURE THAT MICROSOFT® WINDOWS® RECOGNIZES THE DRIVE —**

*Windows XP:*

- Click **Start** and click **My Computer**.

*Windows Vista®:*

- Click the Windows Vista Start button  and click **Computer**.

If the drive is not listed, perform a full scan with your antivirus software to check for and remove viruses. Viruses can sometimes prevent Windows from recognizing the drive.

**TEST THE DRIVE —**

- Insert another floppy disk, CD, or DVD to eliminate the possibility that the original media is defective.
- Insert a bootable floppy disk and restart the computer.

**CLEAN THE DRIVE OR DISK —** See "Cleaning Your Computer" on page 179.

**ENSURE THAT THE CD OR DVD MEDIA IS SNAPPED ONTO THE SPINDLE**

**CHECK THE CABLE CONNECTIONS**

**CHECK FOR HARDWARE INCOMPATIBILITIES —** See "Troubleshooting Software and Hardware Problems" on page 147.

**RUN THE DELL DIAGNOSTICS —** See "Dell Diagnostics" on page 111.

### Optical drive problems

 **NOTE:** High-speed optical drive vibration is normal and may cause noise, which does not indicate a defect in the drive or the media.

 **NOTE:** Because of different regions worldwide and different disc formats, not all DVD titles work in all DVD drives.

### **Problems writing to a CD-RW or DVD+/-RW drive**

**CLOSE OTHER PROGRAMS** — CD-RW and DVD+/-RW drives must receive a steady stream of data when writing. If the stream is interrupted, an error occurs. Try closing all programs before you write to the drive.

### **TURN OFF SLEEP STATE IN WINDOWS BEFORE WRITING TO A CD/DVD DISC** —

See "Power Management Modes" on page 56 for information on sleep modes.

**CHANGE THE WRITE SPEED TO A SLOWER RATE** — See the help files for your CD or DVD creation software.

### **The drive tray cannot eject**

- 1 Ensure that the computer is shut down.
- 2 Straighten a paper clip and insert one end into the eject hole at the front of the drive, then push firmly until the tray is partially ejected.
- 3 Gently pull out the tray until it stops.

### **The drive makes an unfamiliar scraping or grinding sound**

- Ensure that the sound is not caused by the program that is running.
- Ensure that the disc is inserted properly.

### **Hard drive problems**

**ALLOW THE COMPUTER TO COOL BEFORE TURNING IT ON** — A hot hard drive may prevent the operating system from starting. Try allowing the computer to return to room temperature before turning it on.

*Windows XP:*

- 1 Click **Start** and click **My Computer**.
- 2 Right-click **Local Disk C:**.
- 3 Click **Properties**→**Tools**→**Check Now**.
- 4 Click **Scan for and attempt recovery of bad sectors** and click **Start**.

*Windows Vista:*

- 1 Click the Windows Vista Start button  and click **Computer**.
- 2 Right-click **Local Disk C:**.

- 3 Click **Properties**→**Tools**→**Check Now**.

The **User Account Control** window may appear. If you are an administrator on the computer, click **Continue**; otherwise, contact your administrator to continue the desired action.

- 4 Follow the instructions on the screen.

## E-Mail, Modem, and Internet Problems



**CAUTION:** Before you begin any of the procedures in this section, follow the safety instructions in the *Product Information Guide*.



**NOTE:** Connect the modem to an analog telephone jack only. The modem does not operate while it is connected to a digital telephone network.

**CHECK THE MICROSOFT OUTLOOK<sup>®</sup> EXPRESS SECURITY SETTINGS** — If you cannot open your e-mail attachments:

- 1 In Outlook Express, click **Tools**→**Options**→**Security**.
- 2 Click **Do not allow attachments** to remove the check mark, as needed.

### **CHECK THE TELEPHONE LINE CONNECTION**

#### **CHECK THE TELEPHONE JACK**

#### **CONNECT THE MODEM DIRECTLY TO THE TELEPHONE WALL JACK**

### **USE A DIFFERENT TELEPHONE LINE**

- Verify that the telephone line is connected to the jack on the modem (the jack has either a green label or a connector-shaped icon next to it).
- Ensure that you hear a click when you insert the telephone line connector into the modem.
- Disconnect the telephone line from the modem and connect it to a telephone, then listen for a dial tone.
- If you have other telephone devices sharing the line, such as an answering machine, fax machine, surge protector, or line splitter, then bypass them and connect the modem directly to the telephone wall jack. If you are using a line that is 3 m (10 ft) or more in length, try a shorter one.

## **RUN THE MODEM HELPER DIAGNOSTICS —**

*Windows XP:*

- 1 Click **Start**→ **All Programs**→ **Modem Helper**.
- 2 Follow the instructions on the screen to identify and resolve modem problems. Modem Helper is not available on certain computers.

*Windows Vista:*

- 1 Click the Windows Vista Start button → **All Programs**→ **Modem Diagnostic Tool**.
- 2 Follow the instructions on the screen to identify and resolve modem problems. Modem diagnostics are not available on all computers.

## **VERIFY THAT THE MODEM IS COMMUNICATING WITH WINDOWS —**

*Windows XP:*

- 1 Click **Start**→ **Control Panel**→ **Printers and Other Hardware**→ **Phone and Modem Options**→ **Modems**.
- 2 Click the COM port for your modem→ **Properties**→ **Diagnostics**→ **Query Modem** to verify that the modem is communicating with Windows.  
If all commands receive responses, the modem is operating properly.

*Windows Vista:*

- 1 Click the Windows Vista Start button → **Control Panel**→ **Hardware and Sound**→ **Phone and Modem Options**→ **Modems**.
- 2 Click the COM port for your modem→ **Properties**→ **Diagnostics**→ **Query Modem** to verify that the modem is communicating with Windows.  
If all commands receive responses, the modem is operating properly.

**ENSURE THAT YOU ARE CONNECTED TO THE INTERNET —** Ensure that you have subscribed to an Internet service provider. With the Outlook Express e-mail program open, click **File**. If **Work Offline** has a check mark next to it, click the check mark to remove it, and then connect to the Internet. For help, contact your Internet service provider.

**SCAN THE COMPUTER FOR SPYWARE —** If you are experiencing slow computer performance, you frequently receive pop-up advertisements, or you are having problems connecting to the Internet, your computer might be infected with spyware. Use an anti-virus program that includes anti-spyware protection

(your program may require an upgrade) to scan the computer and remove spyware. For more information, go to [support.dell.com](http://support.dell.com) and search for the keyword *spyware*.

## Error Messages



**CAUTION:** Before you begin any of the procedures in this section, follow the safety instructions in the *Product Information Guide*.

If the message is not listed, see the documentation for the operating system or the program that was running when the message appeared.

**AUXILIARY DEVICE FAILURE** — The touch pad or external mouse may be faulty. For an external mouse, check the cable connection. Enable the **Pointing Device** option in the system setup program (see "Using the System Setup Program" on page 175). If the problem persists, contact Dell (see "Contacting Dell" on page 165).

**BAD COMMAND OR FILE NAME** — Ensure that you have spelled the command correctly, put spaces in the proper place, and used the correct pathname.

**CACHE DISABLED DUE TO FAILURE** — The primary cache internal to the microprocessor has failed. Contact Dell (see "Contacting Dell" on page 165).

**CD DRIVE CONTROLLER FAILURE** — The CD drive does not respond to commands from the computer (see "Drive Problems" on page 119).

**DATA ERROR** — The hard drive cannot read the data (see "Drive Problems" on page 119).

**DECREASING AVAILABLE MEMORY** — One or more memory modules may be faulty or improperly seated. Reinstall the memory modules and, if necessary, replace them (see "Memory" on page 95).

**DISK C: FAILED INITIALIZATION** — The hard drive failed initialization. Run the hard drive tests in the Dell Diagnostics (see "Dell Diagnostics" on page 111).

**DRIVE NOT READY** — The operation requires a hard drive in the bay before it can continue. Install a hard drive in the hard drive bay (see "Hard Drive" on page 92).

**ERROR READING PCMCIA CARD** — The computer cannot identify the ExpressCard. Reinsert the card or try another card (see "Using Cards" on page 69).

**EXTENDED MEMORY SIZE HAS CHANGED** — The amount of memory recorded in nonvolatile memory (NVRAM) does not match the memory installed in the computer. Restart the computer. If the error appears again, contact Dell (see "Contacting Dell" on page 165).

**THE FILE BEING COPIED IS TOO LARGE FOR THE DESTINATION DRIVE** — The file that you are trying to copy is too large to fit on the disk, or the disk is full. Try copying the file to a different disk or use a larger capacity disk.

**A FILENAME CANNOT CONTAIN ANY OF THE FOLLOWING CHARACTERS: \ / : \* ? " < > |** — Do not use these characters in filenames.

**GATE A20 FAILURE** — A memory module may be loose. Reinstall the memory modules and, if necessary, replace them (see "Memory" on page 95).

**GENERAL FAILURE** — The operating system is unable to carry out the command. The message is usually followed by specific information—for example, `Printer out of paper`. Take the appropriate action.

**HARD-DISK DRIVE CONFIGURATION ERROR** — The computer cannot identify the drive type. Shut down the computer, remove the hard drive (see "Hard Drive" on page 92), and boot the computer from a CD. Then, shut down the computer, reinstall the hard drive, and restart the computer. Run the Hard Disk Drive tests in the Dell Diagnostics (see "Dell Diagnostics" on page 111).

**HARD-DISK DRIVE CONTROLLER FAILURE 0** — The hard drive does not respond to commands from the computer. Shut down the computer, remove the hard drive (see "Hard Drive" on page 92), and boot the computer from a CD. Then, shut down the computer, reinstall the hard drive, and restart the computer. If the problem persists, try another drive. Run the Hard Disk Drive tests in the Dell Diagnostics (see "Dell Diagnostics" on page 111).

**HARD-DISK DRIVE FAILURE** — The hard drive does not respond to commands from the computer. Shut down the computer, remove the hard drive (see "Hard Drive" on page 92), and boot the computer from a CD. Then, shut down the computer, reinstall the hard drive, and restart the computer. If the problem persists, try another drive. Run the Hard Disk Drive tests in the Dell Diagnostics (see "Dell Diagnostics" on page 111).

**HARD-DISK DRIVE READ FAILURE** — The hard drive may be defective. Shut down the computer, remove the hard drive (see "Hard Drive" on page 92), and boot the computer from a CD. Then, shut down the computer, reinstall the hard drive, and restart the computer. If the problem persists, try another drive. Run the Hard Disk Drive tests in the Dell Diagnostics (see "Dell Diagnostics" on page 111).



**INSERT BOOTABLE MEDIA** — The operating system is trying to boot to nonbootable media, such as a floppy disk or CD. Insert bootable media.

**INVALID CONFIGURATION INFORMATION-PLEASE RUN SYSTEM SETUP PROGRAM** — The system configuration information does not match the hardware configuration. The message is most likely to occur after a memory module is installed. Correct the appropriate options in the system setup program (see "Using the System Setup Program" on page 175).

**KEYBOARD CLOCK LINE FAILURE** — For external keyboards, check the cable connection. Run the Keyboard Controller test in the Dell Diagnostics (see "Dell Diagnostics" on page 111).

**KEYBOARD CONTROLLER FAILURE** — For external keyboards, check the cable connection. Restart the computer, and avoid touching the keyboard or the mouse during the boot routine. Run the Keyboard Controller test in the Dell Diagnostics (see "Dell Diagnostics" on page 111).

**KEYBOARD DATA LINE FAILURE** — For external keyboards, check the cable connection. Run the Keyboard Controller test in the Dell Diagnostics (see "Dell Diagnostics" on page 111).

**KEYBOARD STUCK KEY FAILURE** — For external keyboards or keypads, check the cable connection. Restart the computer, and avoid touching the keyboard or keys during the boot routine. Run the Stuck Key test in the Dell Diagnostics (see "Dell Diagnostics" on page 111).

**LICENSED CONTENT IS NOT ACCESSIBLE IN MEDIADIRECT** — Dell MediaDirect™ cannot verify the Digital Rights Management (DRM) restrictions on the file, so the file cannot be played (see "Dell MediaDirect problems" on page 132).

**MEMORY ADDRESS LINE FAILURE AT ADDRESS, READ VALUE EXPECTING VALUE** — A memory module may be faulty or improperly seated. Reinstall the memory modules and, if necessary, replace them (see "Memory" on page 95).

**MEMORY ALLOCATION ERROR** — The software you are attempting to run is conflicting with the operating system, another program, or a utility. Shut down the computer, wait 30 seconds, and then restart it. Try to run the program again. If the error message still appears, see the software documentation.

**MEMORY DATA LINE FAILURE AT ADDRESS, READ VALUE EXPECTING VALUE** — A memory module may be faulty or improperly seated. Reinstall the memory modules and, if necessary, replace them (see "Memory" on page 95).

**MEMORY DOUBLE WORD LOGIC FAILURE AT ADDRESS, READ VALUE EXPECTING VALUE** — A memory module may be faulty or improperly seated. Reinstall the memory modules and, if necessary, replace them (see "Memory" on page 95).

**MEMORY ODD/EVEN LOGIC FAILURE AT ADDRESS, READ VALUE EXPECTING VALUE** — A memory module may be faulty or improperly seated. Reinstall the memory modules and, if necessary, replace them (see "Memory" on page 95).

**MEMORY WRITE/READ FAILURE AT ADDRESS, READ VALUE EXPECTING VALUE** — A memory module may be faulty or improperly seated. Reinstall the memory modules and, if necessary, replace them (see "Memory" on page 95).

**NO BOOT DEVICE AVAILABLE** — The computer cannot find the hard drive. If the hard drive is your boot device, ensure that the drive is installed, properly seated, and partitioned as a boot device.

**NO BOOT SECTOR ON HARD DRIVE** — The operating system may be corrupted. Contact Dell (see "Contacting Dell" on page 165).

**NO TIMER TICK INTERRUPT** — A chip on the system board may be malfunctioning. Run the System Set tests in the Dell Diagnostics (see "Dell Diagnostics" on page 111).

**NOT ENOUGH MEMORY OR RESOURCES. EXIT SOME PROGRAMS AND TRY AGAIN** — You have too many programs open. Close all windows and open the program that you want to use.

**OPERATING SYSTEM NOT FOUND** — Reinstall the hard drive (see "Hard Drive" on page 92). If the problem persists, contact Dell (see "Dell Diagnostics" on page 111).

**OPTIONAL ROM BAD CHECKSUM** — The optional ROM has failed. Contact Dell (see "Dell Diagnostics" on page 111).

**A REQUIRED .DLL FILE WAS NOT FOUND** — The program that you are trying to open is missing an essential file. Remove and then reinstall the program.

*Windows XP:*

- 1 Click **Start**→ **Control Panel**→ **Add or Remove Programs**→ **Programs and Features**.
- 2 Select the program you want to remove.
- 3 Click **Uninstall**.
- 4 See the program documentation for installation instructions.

*Windows Vista:*

- 1 Click the Windows Vista Start button  → **Control Panel** → **Programs** → **Programs and Features**.
- 2 Select the program you want to remove.
- 3 Click **Uninstall**.
- 4 See the program documentation for installation instructions.

**SECTOR NOT FOUND** — The operating system cannot locate a sector on the hard drive. You may have a defective sector or corrupted FAT on the hard drive. Run the Windows error-checking utility to check the file structure on the hard drive. See Windows Help and Support for instructions (click **Start** → **Help and Support**). If a large number of sectors are defective, back up the data (if possible), and then reformat the hard drive.

**SEEK ERROR** — The operating system cannot find a specific track on the hard drive.

**SHUTDOWN FAILURE** — A chip on the system board may be malfunctioning. Run the System Set tests in the Dell Diagnostics (see "Dell Diagnostics" on page 111).

**TIME-OF-DAY CLOCK LOST POWER** — System configuration settings are corrupted. Connect your computer to an electrical outlet to charge the battery. If the problem persists, try to restore the data by entering the system setup program, then immediately exit the program (see "Using the System Setup Program" on page 175). If the message reappears, contact Dell (see "Contacting Dell" on page 165).

**TIME-OF-DAY CLOCK STOPPED** — The reserve battery that supports the system configuration settings may require recharging. Connect your computer to an electrical outlet to charge the battery. If the problem persists, contact Dell (see "Contacting Dell" on page 165).

**TIME-OF-DAY NOT SET-PLEASE RUN THE SYSTEM SETUP PROGRAM** — The time or date stored in the system setup program does not match the system clock. Correct the settings for the **Date** and **Time** options (see "Using the System Setup Program" on page 175).

**TIMER CHIP COUNTER 2 FAILED** — A chip on the system board may be malfunctioning. Run the System Set tests in the Dell Diagnostics (see "Dell Diagnostics" on page 111).

**UNEXPECTED INTERRUPT IN PROTECTED MODE** — The keyboard controller may be malfunctioning, or a memory module may be loose. Run the System Memory tests and the Keyboard Controller test in the Dell Diagnostics (see "Dell Diagnostics" on page 111).

**X:\ IS NOT ACCESSIBLE. THE DEVICE IS NOT READY** — Insert a disk into the drive and try again.

**WARNING: BATTERY IS CRITICALLY LOW** — The battery is running out of charge. Replace the battery, or connect the computer to an electrical outlet; otherwise, activate hibernate mode or shut down the computer.

## ExpressCard Problems

 **CAUTION:** Before you begin any of the procedures in this section, follow the safety instructions in the *Product Information Guide*.

**CHECK THE EXPRESSCARD** — Ensure that the ExpressCard is properly inserted into the connector.

**CHECK THAT THE CARD IS RECOGNIZED BY WINDOWS** — Double-click the **Safely Remove Hardware** icon in the Windows taskbar. Some cards do not support this feature. If the card supports this Windows feature, the card will be listed.

**IF YOU HAVE PROBLEMS WITH A DELL-PROVIDED EXPRESSCARD** — Contact Dell (see "Contacting Dell" on page 165). Also, for Mobile Broadband (WWAN) ExpressCards, see "Mobile Broadband (Wireless Wide Area Network [WWAN])" on page 135.

**IF YOU HAVE PROBLEMS WITH AN EXPRESSCARD NOT PROVIDED BY DELL** — Contact the ExpressCard manufacturer.

## IEEE 1394 Device Problems

 **CAUTION:** Before you begin any of the procedures in this section, follow the safety instructions in the *Product Information Guide*.

**ENSURE THAT THE IEEE 1394 DEVICE IS RECOGNIZED BY WINDOWS** —

- 1 Click Start→ Control Panel→ System and Maintenance→ Device Manager.

 **NOTE:** The User Account Control window may appear. If you are an administrator on the computer, click **Continue**; otherwise, contact your administrator to continue the desired action.

If your IEEE 1394 device is listed, Windows recognizes the device.

**IF YOU HAVE PROBLEMS WITH A DELL-PROVIDED IEEE 1394 DEVICE** — Contact Dell or the IEEE 1394 device manufacturer (see "Contacting Dell" on page 165).

**IF YOU HAVE PROBLEMS WITH AN IEEE 1394 DEVICE NOT PROVIDED BY DELL** — Contact Dell or the IEEE 1394 device manufacturer (see "Contacting Dell" on page 165).

Ensure that the IEEE 1394 device is properly inserted into the connector

## Keyboard Problems



**CAUTION:** Before you begin any of the procedures in this section, follow the safety instructions in the *Product Information Guide*.



**NOTE:** Use the integrated keyboard when running the Dell Diagnostics or the system setup program. When you attach an external keyboard, the integrated keyboard remains fully functional.

### External Keyboard problems



**NOTE:** When you attach an external keyboard, the integrated keyboard remains fully functional.

**CHECK THE KEYBOARD CABLE** — Shut down the computer, disconnect the keyboard cable and check it for damage, then firmly reconnect the cable.

If you are using a keyboard extension cable, disconnect it and connect the keyboard directly to the computer.

#### **CHECK THE EXTERNAL KEYBOARD** —

- 1 Shut down the computer, wait 1 minute, and then turn it on again.
- 2 Verify that the numbers, capitals, and scroll lock lights on the keyboard blink during the boot routine.
- 3 From the Windows desktop, click **Start**→ **All Programs**→ **Accessories**→ **Notepad**.
- 4 Type some characters on the external keyboard and verify that they appear on the display.

If you cannot verify these steps, you may have a defective external keyboard.

**TO VERIFY THAT THE PROBLEM IS WITH THE EXTERNAL KEYBOARD, CHECK THE INTEGRATED KEYBOARD —**

- 1 Shut down the computer.
- 2 Disconnect the external keyboard.
- 3 Turn on the computer.
- 4 From the Windows desktop, click **Start**→ **All Programs**→ **Accessories**→ **Notepad**.
- 5 Type some characters on the internal keyboard and verify that they appear on the display.

If the characters appear now, but did not with the external keyboard, you may have a defective external keyboard. Contact Dell (see "Contacting Dell" on page 165).

**RUN THE KEYBOARD DIAGNOSTICS TESTS —** Run the PC-AT Compatible Keyboards tests in the Dell Diagnostics (see "Dell Diagnostics" on page 111). If the tests indicate a defective external keyboard, contact Dell (see "Contacting Dell" on page 165).

### **Unexpected characters**

**DISABLE THE NUMERIC KEYPAD —** Press <Num Lock> to disable the numeric keypad if numbers are displayed instead of letters. Verify that the numbers lock light is not lit.

## **Lockups and Software Problems**



**CAUTION:** Before you begin any of the procedures in this section, follow the safety instructions in the *Product Information Guide*.

### **The computer does not start**

**CHECK THE AC ADAPTER —** Ensure that the AC adapter is firmly connected to the computer and to the electrical outlet.

The AC adapter shuts down when there is a fault. The green light turns off when this happens. To bring it back on, disconnect the AC adapter from the power source for 10 seconds, and then connect it back on.

## The computer stops responding



**NOTICE:** You might lose data if you are unable to perform an operating system shutdown.

**TURN THE COMPUTER OFF** — If you are unable to get a response by pressing a key on your keyboard or moving your mouse, press and hold the power button for at least 8 to 10 seconds until the computer turns off, then restart your computer.

## A program stops responding or crashes repeatedly

### END THE PROGRAM —

- 1 Press <Ctrl><Shift><Esc> simultaneously to access the Task Manager.
- 2 Click the **Applications** tab.
- 3 Click to select the program that is no longer responding.
- 4 Click **End Task**.



**NOTE:** The chkdsk program may run when you restart the computer. Follow the instructions on the screen.

**CHECK THE SOFTWARE DOCUMENTATION** — If necessary, uninstall and then reinstall the program. Software usually includes installation instructions in its documentation or on a floppy disk or CD.

## A program is designed for an earlier Microsoft® Windows® operating system

### RUN THE PROGRAM COMPATIBILITY WIZARD —

*Windows XP:*

The Program Compatibility Wizard configures a program so that it runs in an environment similar to non-XP operating system environments.

- 1 Click **Start**→ **All Programs**→ **Accessories**→ **Program Compatibility Wizard**→ **Next**.
- 2 Follow the instructions on the screen.

*Windows Vista:*

The Program Compatibility Wizard configures a program so that it runs in an environment similar to non-Windows Vista operating system environments.

- 1 Click **Start**  → **Control Panel** → **Programs** → **Use an older program with this version of Windows**.
- 2 In the welcome screen, click **Next**.
- 3 Follow the instructions on the screen.

## **A solid blue screen appears**

**TURN THE COMPUTER OFF** — If you are unable to get a response by pressing a key on your keyboard or moving your mouse, press and hold the power button for at least 8 to 10 seconds until the computer turns off, then restart your computer.

## **Dell MediaDirect problems**

**CHECK THE DELL MEDIADIRECT HELP FILE FOR INFORMATION** — Use the **Help** menu to access Dell MediaDirect Help.

**TO PLAY MOVIES WITH DELL MEDIADIRECT, YOU MUST HAVE A DVD DRIVE AND THE DELL DVD PLAYER** — If you purchased a DVD drive with your computer, this software should already be installed.

**VIDEO QUALITY PROBLEMS** — Turn off the **Use Hardware Acceleration** option. This feature takes advantage of the special processing in some graphics cards to reduce processor requirements when playing DVDs and certain types of video files.

**CANNOT PLAY SOME MEDIA FILES** — Because Dell MediaDirect provides access to media files outside the Windows operating system environment, access to licensed content is restricted. Licensed content is digital content that has Digital Rights Management (DRM) applied to it. The Dell MediaDirect environment cannot verify the DRM restrictions, so the licensed files cannot be played. Licensed music and video files have a lock icon next to them. You can access licensed files in the Windows operating system environment.

**ADJUSTING THE COLOR SETTINGS FOR MOVIES THAT CONTAIN SCENES THAT ARE TOO DARK OR TOO BRIGHT** — Click **EagleVision** to use a video enhancement technology that detects video content and dynamically adjusts the brightness/contrast/saturation ratios.



-  **NOTICE:** You cannot reinstall the Dell MediaDirect feature if you voluntarily reformat the hard drive. Contact Dell for assistance (see "Contacting Dell" on page 165).

## Other software problems

### **CHECK THE SOFTWARE DOCUMENTATION OR CONTACT THE SOFTWARE MANUFACTURER FOR TROUBLESHOOTING INFORMATION —**

- Ensure that the program is compatible with the operating system installed on your computer.
- Ensure that your computer meets the minimum hardware requirements needed to run the software. See the software documentation for information.
- Ensure that the program is installed and configured properly.
- Verify that the device drivers do not conflict with the program.
- If necessary, uninstall and then reinstall the program.

### **BACK UP YOUR FILES IMMEDIATELY**

### **USE A VIRUS-SCANNING PROGRAM TO CHECK THE HARD DRIVE, FLOPPY DISKS, OR CDS**

### **SAVE AND CLOSE ANY OPEN FILES OR PROGRAMS AND SHUT DOWN YOUR COMPUTER THROUGH THE START MENU**

**SCAN THE COMPUTER FOR SPYWARE —** If you are experiencing slow computer performance, you frequently receive pop-up advertisements, or you are having problems connecting to the Internet, your computer might be infected with spyware. Use an anti-virus program that includes anti-spyware protection (your program may require an upgrade) to scan the computer and remove spyware. For more information, go to [support.dell.com](http://support.dell.com) and search for the keyword *spyware*.

**RUN THE DELL DIAGNOSTICS —** If all tests run successfully, the error condition is related to a software problem (see "Dell Diagnostics" on page 111).

## Memory Problems

 **CAUTION:** Before you begin any of the procedures in this section, follow the safety instructions in the *Product Information Guide*.

#### **IF YOU RECEIVE AN INSUFFICIENT MEMORY MESSAGE —**

- Save and close any open files and exit any open programs you are not using to see if that resolves the problem.
- See the software documentation for minimum memory requirements. If necessary, install additional memory (see "Memory" on page 95).
- Reseat the memory modules to ensure that your computer is successfully communicating with the memory (see "Memory" on page 95).
- Run the Dell Diagnostics (see "Dell Diagnostics" on page 111).

#### **IF YOU EXPERIENCE OTHER MEMORY PROBLEMS —**

- Reseat the memory modules to ensure that your computer is successfully communicating with the memory (see "Memory" on page 95).
- Ensure that you are following the memory installation guidelines (see "Memory" on page 95).
- Ensure that the memory you are using is supported by your computer. For more information about the type of memory supported by your computer, see "Memory" on page 95.
- Run the Dell Diagnostics (see "Dell Diagnostics" on page 111).

## **Network Problems**



**CAUTION:** Before you begin any of the procedures in this section, follow the safety instructions in the *Product Information Guide*.

**CHECK THE NETWORK CABLE CONNECTOR —** Ensure that the network cable is firmly inserted into both the network connector on the back of the computer and the network jack.



**CHECK THE NETWORK LIGHTS ON THE NETWORK CONNECTOR —** No light indicates that no network communication exists. Replace the network cable.



**RESTART THE COMPUTER AND LOG ON TO THE NETWORK AGAIN**

**CHECK YOUR NETWORK SETTINGS —** Contact your network administrator or the person who set up your network to verify that your network settings are correct and that the network is functioning.

## Mobile Broadband (Wireless Wide Area Network [WWAN])

 **NOTE:** The Dell Mobile Broadband Card Utility user's guide and the Mobile Broadband ExpressCard user's guide are available through Windows Help and Support (click **Start**→**Help and Support**). You can also download the Dell Mobile Broadband Card Utility user's guide from [support.dell.com](http://support.dell.com).

 **NOTE:** The  icon appears in the notification area if the computer has a Dell WWAN device installed. Double-click the icon to launch the utility.

**ACTIVATE THE MOBILE BROADBAND EXPRESSCARD** — You must activate the Mobile Broadband ExpressCard before you can connect to the network. Position the mouse over the  icon in the notification area to verify the status of the connection. If the card is not activated, follow the card activation instructions located within the Dell Mobile Broadband Card Utility. To access the utility, double-click the  icon located in the taskbar, at the lower-right corner of your screen. If your ExpressCard is not a Dell-branded card, see the manufacturer's instructions for your card.

**CHECK NETWORK CONNECTION STATUS IN THE DELL MOBILE BROADBAND CARD UTILITY** — Double-click the  icon to launch the Dell Mobile Broadband Card Utility. Check the status in the main window:

- **No card detected** — Restart the computer, and launch the Dell Mobile Broadband Card Utility again.
- **Check your WWAN service** — Contact your cellular service provider to verify your plan coverage and supported services.

## Power Problems

 **CAUTION:** Before you begin any of the procedures in this section, follow the safety instructions in the *Product Information Guide*.

**CHECK THE POWER LIGHT** — When the power light is lit or blinking, the computer has power. If the power light is blinking, the computer is in Sleep state—press the power button to exit Sleep state. If the light is off, press the power button to turn on the computer.

 **NOTE:** For information on the Sleep power state, see "Power Management Modes" on page 56.

**CHARGE THE BATTERY** — The battery charge may be depleted.

- 1 Reinstall the battery.
- 2 Use the AC adapter to connect the computer to an electrical outlet.
- 3 Turn on the computer.



**NOTE:** Battery operating time (the time the battery can hold a charge) decreases over time. Depending on how often the battery is used and the conditions under which it is used, you may need to purchase a new battery during the life of your computer.

**CHECK THE BATTERY STATUS LIGHT** — If the battery status light flashes amber or is a steady amber, the battery charge is low or depleted. Connect the computer to an electrical outlet.

If the battery status light flashes blue and amber, the battery is too hot to charge. Shut down the computer, disconnect the computer from the electrical outlet, and then let the battery and computer cool to room temperature.

If the battery status light rapidly flashes amber, the battery may be defective. See "Contacting Dell" on page 165.

**CHECK THE BATTERY TEMPERATURE** — If the battery temperature is below 0°C (32°F), the computer will not start.

**TEST THE ELECTRICAL OUTLET** — Ensure that the electrical outlet is working by testing it with another device, such as a lamp.

**CHECK THE AC ADAPTER** — Check the AC adapter cable connections. If the AC adapter has a light, ensure that the light is on.

**CONNECT THE COMPUTER DIRECTLY TO AN ELECTRICAL OUTLET** — Bypass power protection devices, power strips, and extension cables to verify that the computer turns on.

**ELIMINATE POSSIBLE INTERFERENCE** — Turn off nearby fans, fluorescent lights, halogen lamps, or other appliances.

**ADJUST THE POWER PROPERTIES** — See "Power Management Modes" on page 56.

**RESET THE MEMORY MODULES** — If the computer power light turns on, but the display remains blank, reinstall the memory modules (see "Memory" on page 95).

# Printer Problems



**CAUTION:** Before you begin any of the procedures in this section, follow the safety instructions in the *Product Information Guide*.



**NOTE:** If you need technical assistance for your printer, contact the printer's manufacturer.

**CHECK THE PRINTER DOCUMENTATION** — See the printer documentation for setup and troubleshooting information.

**ENSURE THAT THE PRINTER IS TURNED ON**

**CHECK THE PRINTER CABLE CONNECTIONS** —

- See the printer documentation for cable connection information.
- Ensure that the printer cables are securely connected to the printer and the computer.

**TEST THE ELECTRICAL OUTLET** — Ensure that the electrical outlet is working by testing it with another device, such as a lamp.

**VERIFY THAT THE PRINTER IS RECOGNIZED BY WINDOWS** —

*Windows XP:*

- 1 Click **Start**→ **Control Panel**→ **Printers and Other Hardware**→ **View installed printers or fax printers**.
- 2 If the printer is listed, right-click the printer icon.
- 3 Click **Properties**→ **Ports**. For a parallel printer, ensure that the **Print to the following port(s)**: setting is **LPT1 (Printer Port)**. For a USB printer, ensure that the **Print to the following port(s)**: setting is **USB**.

*Windows Vista:*

- 1 Click the Windows Vista Start button  → **Control Panel**→ **Hardware and Sound**→ **Printer**.
- 2 If the printer is listed, right-click the printer icon.
- 3 Click **Properties and click Ports**.
- 4 Adjust the settings, as needed.

**REINSTALL THE PRINTER DRIVER** — See the printer documentation for instructions.

## Scanner Problems

 **CAUTION:** Before you begin any of the procedures in this section, follow the safety instructions in the *Product Information Guide*.

 **NOTE:** If you need technical assistance for your scanner, contact the scanner's manufacturer.

**CHECK THE SCANNER DOCUMENTATION** — See the scanner documentation for setup and troubleshooting information.

**UNLOCK THE SCANNER** — Ensure that your scanner is unlocked.

**RESTART THE COMPUTER AND TRY THE SCANNER AGAIN**

**CHECK THE CABLE CONNECTIONS** —

- See the scanner documentation for cable connection information.
- Ensure that the scanner cables are securely connected to the scanner and the computer.

**VERIFY THAT THE SCANNER IS RECOGNIZED BY MICROSOFT WINDOWS** —

*Windows XP:*

- 1 Click Start → Control Panel → Printers and Other Hardware → Scanners and Cameras.
- 2 If your scanner is listed, Windows recognizes the scanner.

*Windows Vista:*

- 1 Click the Windows Vista Start button  → Control Panel → Hardware and Sound → Scanners and Cameras.
- 2 If the scanner is listed, Windows recognizes the scanner.

**REINSTALL THE SCANNER DRIVER** — See the scanner documentation for instructions.

## Sound and Speaker Problems

 **CAUTION:** Before you begin any of the procedures in this section, follow the safety instructions in the *Product Information Guide*.

## No sound from integrated speakers

**ADJUST THE WINDOWS VOLUME CONTROL** — Double-click the speaker icon in the lower-right corner of your screen. Ensure that the volume is turned up and that the sound is not muted. Adjust the volume, bass, or treble controls to eliminate distortion.

**ADJUST THE VOLUME USING KEYBOARD SHORTCUTS** — Press <Fn><End> to disable (mute) or re-enable the integrated speakers.

**REINSTALL THE SOUND (AUDIO) DRIVER** — See "Reinstalling Drivers and Utilities" on page 144.

## No sound from external speakers

**ENSURE THAT THE SUBWOOFER AND THE SPEAKERS ARE TURNED ON** — See the setup diagram supplied with the speakers. If your speakers have volume controls, adjust the volume, bass, or treble to eliminate distortion.

**ADJUST THE WINDOWS VOLUME CONTROL** — Click or double-click the speaker icon in the lower-right corner of your screen. Ensure that the volume is turned up and that the sound is not muted.

**DISCONNECT HEADPHONES FROM THE HEADPHONE CONNECTOR** — Sound from the speakers is automatically disabled when headphones are connected to the headphone connector.

**TEST THE ELECTRICAL OUTLET** — Ensure that the electrical outlet is working by testing it with another device, such as a lamp.

**ELIMINATE POSSIBLE INTERFERENCE** — Turn off nearby fans, fluorescent lights, or halogen lamps to check for interference.

**REINSTALL THE AUDIO DRIVER** — See "Reinstalling Drivers and Utilities" on page 144.

**RUN THE DELL DIAGNOSTICS** — See "Dell Diagnostics" on page 111.



**NOTE:** The volume control in some MP3 players overrides the Windows volume setting. If you have been listening to MP3 songs, ensure that you did not turn the player volume down or off.

## No sound from headphones

**CHECK THE HEADPHONE CABLE CONNECTION** — Ensure that the headphone cable is securely inserted into the headphone connector (see "ExpressCards" on page 69).

**ADJUST THE WINDOWS VOLUME CONTROL** — Click or double-click the speaker icon in the lower-right corner of your screen. Ensure that the volume is turned up and that the sound is not muted.

## Remote Control Problems

### **APPLICATION DOES NOT RESPOND TO REMOTE CONTROL WITHIN THE SPECIFIED MAXIMUM RANGE**

- Check that the battery is placed correctly with the "+" side facing up. Check that the battery is also not weak.
- Point your remote control to the receiver. The receiver is underneath the touch pad of your computer.
- Move the remote control closer to your computer.

### **REMOTE CONTROL IS STUCK IN THE SLOT**

Check that you have not incorrectly stored the remote control into a non-Express Card slot. Contact Dell Technical Support for removing it.

## Touch Pad or Mouse Problems

### **CHECK THE TOUCH PAD SETTINGS** —

*Windows XP:*

- 1 Click **Start** → **Control Panel** → **Mouse**.
- 2 Adjust the settings, as needed.

*Windows Vista:*

- 1 Click the Windows Vista Start button  → **Control Panel** → **Hardware and Sound** → **Mouse**.
- 2 Adjust the settings, as needed.

**CHECK THE MOUSE CABLE** — Shut down the computer, disconnect the mouse cable and check it for damage, then firmly reconnect the cable.

If you are using a mouse extension cable, disconnect it and connect the mouse directly to the computer.

### **TO VERIFY THAT THE PROBLEM IS WITH THE MOUSE, CHECK THE TOUCH PAD** —

- 1 Shut down the computer.
- 2 Disconnect the mouse.



- 3 Turn on the computer.
- 4 At the Windows desktop, use the touch pad to move the cursor around, select an icon, and open it.

If the touch pad operates correctly, the mouse may be defective.

**CHECK THE SYSTEM SETUP PROGRAM SETTINGS** — Verify that the system setup program lists the correct device for the pointing device option (the computer automatically recognizes a USB mouse without making any setting adjustments).

**TEST THE MOUSE CONTROLLER** — To test the mouse controller (which affects pointer movement) and the operation of the touch pad or mouse buttons, run the Mouse test in the **Pointing Devices** test group in the "Dell Diagnostics" on page 111.

**REINSTALL THE TOUCH PAD DRIVER** — See "Reinstalling Drivers and Utilities" on page 144.

## Video and Display Problems



**CAUTION:** Before you begin any of the procedures in this section, follow the safety instructions in the *Product Information Guide*.

### If the display is blank



**NOTE:** If you are using a program that requires a higher resolution than your computer supports, it is recommended that you attach an external monitor to your computer.

**CHECK THE BATTERY** — If you are using a battery to power your computer, the battery charge may be depleted. Connect the computer to an electrical outlet using the AC adapter, and then turn on the computer.

**TEST THE ELECTRICAL OUTLET** — Ensure that the electrical outlet is working by testing it with another device, such as a lamp.

**CHECK THE AC ADAPTER** — Check the AC adapter cable connections. If the AC adapter has a light, ensure that the light is on.

**CONNECT THE COMPUTER DIRECTLY TO AN ELECTRICAL OUTLET** — Bypass power protection devices, power strips, and extension cables to verify that the computer turns on.

**ADJUST THE POWER PROPERTIES** — Search for the keyword *sleep* in Windows Help and Support.

**SWITCH THE VIDEO IMAGE** — If your computer is attached to an external monitor, press <Fn><F8> to switch the video image to the display.

### **If the display is difficult to read**

**ADJUST THE BRIGHTNESS** — Press <Fn> and the up- or down-arrow key.

**MOVE THE EXTERNAL SUBWOOFER AWAY FROM THE COMPUTER OR MONITOR** — If your external speaker system includes a subwoofer, ensure that the subwoofer is at least 60 cm (2 ft) away from the computer or external monitor.

**ELIMINATE POSSIBLE INTERFERENCE** — Turn off nearby fans, fluorescent lights, halogen lamps, or other appliances.

**ROTATE THE COMPUTER TO FACE A DIFFERENT DIRECTION** — Eliminate sunlight glare, which can cause poor picture quality.

**ADJUST THE WINDOWS DISPLAY SETTINGS** —

*Windows XP:*

- 1 Click **Start**→ **Control Panel**→ **Appearance and Themes**.
- 2 Click the area you want to change or click the **Display** icon.
- 3 Try different settings for **Color quality** and **Screen resolution**.

*Windows Vista:*

- 1 Click the Windows Vista Start button  → **Control Panel**→ **Hardware and Sound**→ **Personalization**→ **Display Settings**.
- 2 Adjust **Resolution** and **Colors** settings, as needed.

**RUN THE VIDEO DIAGNOSTICS TESTS** — If no error message appears and you still have a display problem, but the display is not completely blank, run the **Video** device group in the "Dell Diagnostics" on page 111, then contact Dell (see "Contacting Dell" on page 165).

**SEE "ERROR MESSAGES"** — If an error message appears, see "Error Messages" on page 123.

## If only part of the display is readable

### CONNECT AN EXTERNAL MONITOR —

- 1 Shut down your computer and connect an external monitor to the computer.
- 2 Turn on the computer and the monitor, and then adjust the monitor brightness and contrast controls.

If the external monitor works, the computer display or video controller may be defective. Contact Dell (see "Contacting Dell" on page 165).

## Drivers

### What Is a Driver?

A driver is a program that controls a device such as a printer, mouse, or keyboard. All devices require a driver program.

A driver acts like a translator between the device and any other programs that use the device. Each device has its own set of specialized commands that only its driver recognizes.

Dell ships your computer to you with required drivers already installed—no further installation or configuration is needed.



**NOTICE:** Your *Drivers and Utilities* media may contain drivers for operating systems that are not on your computer. Ensure that you are installing software appropriate for your operating system.

Many drivers, such as the keyboard driver, come with your Microsoft® Windows® operating system. You may need to install drivers if you:

- Upgrade your operating system.
- Reinstall your operating system.
- Connect or install a new device.

### Identifying Drivers

If you experience a problem with any device, identify whether the driver is the source of your problem and, if necessary, update the driver.

*Windows XP:*

- 1 Click **Start**→ **Control Panel**.
- 2 Under **Pick a Category**, click **Performance and Maintenance**, and click **System**.
- 3 In the **System Properties** window, click the **Hardware** tab, and click **Device Manager**.

*Windows Vista:*

- 1 Click the Windows Vista Start button  and right-click **Computer**.
- 2 Click **Properties**→ **Device Manager**.



**NOTE:** The **User Account Control** window may appear. If you are an administrator on the computer, click **Continue**; otherwise, contact your administrator to continue.

Scroll down the list to see if any device has an exclamation point (a yellow circle with a [!]) on the device icon.

If an exclamation point is next to the device name, you may need to reinstall the driver or install a new driver (see "Reinstalling Drivers and Utilities" on page 144).

## **Reinstalling Drivers and Utilities**



**NOTICE:** The Dell Support website at [support.dell.com](http://support.dell.com) and your *Drivers and Utilities* media provide approved drivers for Dell computers. If you install drivers obtained from other sources, your computer might not work correctly.

### **Using Windows Device Driver Rollback**

If a problem occurs on your computer after you install or update a driver, use Windows Device Driver Rollback to replace the driver with the previously installed version.

*Windows XP:*

- 1 Click **Start**→ **My Computer**→ **Properties**→ **Hardware**→ **Device Manager**.
- 2 Right-click the device for which the new driver was installed and click **Properties**.
- 3 Click the **Drivers** tab→ **Roll Back Driver**.

*Windows Vista:*

- 1 Click the Windows Vista start button , and right-click **Computer**.
- 2 Click **Properties**→ **Device Manager**.



**NOTE:** The **User Account Control** window may appear. If you are an administrator on the computer, click **Continue**; otherwise, contact your administrator to enter the Device Manager.

- 3 Right-click the device for which the new driver was installed and click **Properties**.
- 4 Click the **Drivers** tab→**Roll Back Driver**.

If Device Driver Rollback does not resolve the problem, use System Restore (see "Restoring Your Microsoft® Windows Vista® Operating System" on page 148) to return your computer to the operating state that existed before you installed the new driver.

### **Using the Drivers and Utilities Media**

If using Device Driver Rollback or System Restore (see "Restoring Your Microsoft® Windows Vista® Operating System" on page 148) does not resolve the problem, reinstall the driver from your *Drivers and Utilities* media.

- 1 With the Windows desktop displayed, insert your *Drivers and Utilities* media.

If this is your first time to use your *Drivers and Utilities* media, continue to step 2. If not, proceed to step 5.

- 2 When the *Drivers and Utilities* installation program starts, follow the prompts on the screen.



**NOTE:** In most cases, the *Drivers and Utilities* program starts running automatically. If it does not, start Windows Explorer, click your media drive directory to display the media contents, and then double-click the **autorcd.exe** file.

- 3 When the **InstallShield Wizard Complete** window appears, remove the *Drivers and Utilities* disc and click **Finish** to restart the computer.
- 4 When you see the Windows desktop, reinsert the *Drivers and Utilities* disc.

- 5 At the **Welcome Dell System Owner** screen, click **Next**.



**NOTE:** The *Drivers and Utilities* program displays drivers only for hardware that came installed in your computer. If you installed additional hardware, the drivers for the new hardware might not be displayed. If those drivers are not displayed, exit the *Drivers and Utilities* program. For drivers information, see the documentation that came with the device.

A message stating that the *Drivers and Utilities* program is detecting hardware in your computer appears.

The drivers that are used by your computer are automatically displayed in the **My Drivers—The ResourceCD has identified these components in your system** window.

- 6 Click the driver that you want to reinstall and follow the instructions on the screen.

If a particular driver is not listed, then that driver is not required by your operating system.

## Manually Reinstalling Drivers



**NOTE:** If your computer has a Consumer IR port and you are reinstalling a Consumer IR driver, you must first enable the Consumer IR port in the system setup program (see "Using the System Setup Program" on page 175) before continuing with the driver installation (see "Reinstalling Drivers and Utilities" on page 144). For information about components installed on your computer, see "Determining Your Computer's Configuration" on page 19.

After extracting the driver files to your hard drive, as described in the previous section:

*Windows XP:*

- 1 Click **Start**→ **My Computer**→ **Properties**→ **Hardware**→ **Device Manager**.
- 2 Double-click the type of device for which you are installing the driver (for example, **Audio** or **Video**).
- 3 Double-click the name of the device for which you are installing the driver.
- 4 Click the **Driver** tab→ **Update Driver**.
- 5 Click **Install from a list or specific location (Advanced)**→ **Next**.
- 6 Click **Browse** and browse to the location to which you previously copied the driver files.

- 7 When the name of the appropriate driver appears, click **Next**.
- 8 Click **Finish** and restart your computer.

*Windows Vista:*

- 1 Click the Windows Vista start button , and right-click **Computer**.
- 2 Click **Properties**→ **Device Manager**.



**NOTE:** The **User Account Control** window may appear. If you are an administrator on the computer, click **Continue**; otherwise, contact your administrator to enter the Device Manager.

- 3 Double-click the type of device for which you are installing the driver (for example, **Audio** or **Video**).
- 4 Double-click the name of the device for which you are installing the driver.
- 5 Click the **Driver** tab→ **Update Driver**→ **Browse my computer for driver software**.
- 6 Click **Browse** and browse to the location to which you previously copied the driver files.
- 7 When the name of the appropriate driver appears, click the name of the driver→ **OK**→ **Next**.
- 8 Click **Finish** and restart your computer.

## Troubleshooting Software and Hardware Problems

If a device is either not detected during the operating system setup or is detected but incorrectly configured, you can use the Hardware Troubleshooter to resolve the incompatibility.



**NOTE:** Windows Vista<sup>®</sup> is a new operating system, so drivers or applications that support certain devices may not yet be available. Check with your hardware manufacturer for information on Windows Vista support for your device.

To start the Hardware Troubleshooter:

*Windows XP:*

- 1 Click **Start**→ **Help and Support**.
- 2 Type `hardware troubleshooter` in the search field and press <Enter> to start the search.

- 3 In the **Fix a Problem** section, click **Hardware Troubleshooter**.
- 4 In the **Hardware Troubleshooter** list, select the option that best describes the problem and click **Next** to follow the remaining troubleshooting steps.

*Windows Vista:*

- 1 Click the Windows Vista Start button  and click **Help and Support**.
- 2 In the **Find an answer** section, click **Troubleshooting**.

OR

Type `hardware troubleshooter` in the search field, and then press <Enter>.

- 3 In the search results, select the option that best describes the problem and follow the remaining troubleshooting steps.



**NOTE:** If you do not find the answer in the items categorized in **Troubleshooting**, you can get online help by typing your question in the **Search Help** field at the top of the window.

## Restoring Your Microsoft® Windows Vista® Operating System

You can restore your Windows Vista operating system in the following ways:

- Windows Vista includes the Backup and Restore Center to create backups of important files on your computer or to back up the entire hard drive. You can then restore your operating system or files if needed.
- Microsoft Windows System Restore returns your hard drive to an earlier operating state without affecting data files. Use System Restore as the first solution for restoring your operating system and preserving data files. For instructions, see "Using Microsoft Windows System Restore" on page 154.
- Dell Factory Image Restore restores your hard drive to the operating state it was in when you purchased the computer. Dell Factory Image Restore permanently deletes all data on the hard drive and removes any applications installed after you received the computer. Use Factory Image Restore only if System Restore did not resolve your operating system problem.



- If you received an *Operating System* disc with your computer, you can use it to restore your operating system. However, using the *Operating System* disc also deletes all data on the hard drive. Use the disc *only* if System Restore did not resolve your operating system problem.

## Using Windows Vista System Restore

The Windows Vista operating system provides System Restore to allow you to return your computer to an earlier operating state (without affecting data files) if changes to the hardware, software, or other system settings have left the computer in an undesirable operating state. See the Windows Help and Support Center for information on using System Restore.

To access the Windows Help and Support Center, click the Windows Vista Start button  → **Help and Support**.



**NOTICE:** Make regular backups of your data files. System Restore does not monitor your data files or recover them.



**NOTE:** The procedures in this document were written for the Windows default view, so they may not apply if you set your Dell computer to the Windows Classic view.

## Creating a Restore Point

You can either automatically or manually create a restore point from the Windows Vista Back Up and Restore Center. To access the Windows Vista Backup and Restore Center:

- Click the Windows Vista Start button  → **Welcome Center**. In the **Get started with Windows** section, click **Show all 14 items...** → **Back Up and Restore Center**.

OR

- Click the Windows Vista Start button  → **All Programs** → **Maintenance** → **Back Up and Restore Center**. Under **Tasks**, click **Create a restore point or change settings**.

For more information:

- 1 Click the Windows Vista Start button  → **Help and Support**.
- 2 Type **System Restore** in the search field and press <Enter>.

## Restoring the Computer to an Earlier Operating State

If problems occur after you install a device driver, use Device Driver Rollback (see "Using Windows Device Driver Rollback" on page 144) to resolve the problem. If Device Driver Rollback does not resolve the problem, then use System Restore.



**NOTICE:** Before you restore the computer to an earlier operating state, save and close all open files and exit any open programs. Do not alter, open, or delete any files or programs until the system restoration is complete.

- 1 Click the Windows Vista Start button  → Control Panel → System and Maintenance → Back Up and Restore Center.
- 2 In the Tasks list, click **Repair Windows using System Restore**.
- 3 Click **Continue** in the **User Account Control (UAC)** dialog box asking for permission to run the application.
- 4 Click **Next** in the **System Restore** window to view the most recent restore points in chronological order.
- 5 Select the **Show restore points older than 5 days** check box to view the complete list of restore points.
- 6 Select a restore point. Try to restore from the most recent restore point. If this restore point fails to correct the problem, try the next oldest restore point until the issue is resolved. Any software installed after the selected restore point will need to be reinstalled.
- 7 Click **Next** → **Finish**.
- 8 When prompted, click **Yes**.
- 9 After System Restore finishes collecting data, the computer restarts.
- 10 After the computer restarts, click **OK**.

To change the restore point, you can either repeat the steps using a different restore point, or you can undo the restoration.

If you encounter any error messages during the restore process, follow the prompts on the screen to correct the error.

## Undoing the Last System Restore



 **NOTICE:** Before you undo the last system restore, save and close all open files and exit any open programs. Do not alter, open, or delete any files or programs until the system restoration is complete.

- 1 Click the Windows Vista Start button  → **Help and Support**.
- 2 Type **System Restore** in the search field and press <Enter>.
- 3 Click **Undo my last restoration**, and then click **Next**.

## Restoring the Computer to the Default Factory Configuration

The **Dell Factory Image Restore** option allows you to restore your hard drive back to its original factory configuration as when you first purchased it from Dell. This option appears on Dell computers that were originally pre-installed with the Windows Vista<sup>®</sup> operating system and does not include computers purchased through the Express Upgrade promotion or computers that were upgraded to Windows Vista from a previous version of the Windows<sup>®</sup> operating systems.

 **NOTICE:** When you restore the computer to the default factory configuration, all data on the hard drive is deleted. Before performing this procedure, back up personal files. If you do not back up personal files, the data is lost.

- 1 Restart the computer. To do this, click the Windows Vista Start button  →  → **Restart**.
- 2 As the computer restarts, press <F8> until the **Advanced Boot Options** menu appears on the screen.

 **NOTE:** You must press the <F8> key before the Windows logo appears on the screen. If you press <F8> after the Windows logo appears on the screen, the **Advanced Boot Options** menu will not appear on the screen. If you do not see the **Advanced Boot Options** menu, restart the computer, and then repeat this step until you see the menu on the screen.

- 3 Press <Down Arrow> to select **Repair Your Computer** on the **Advanced Boot Options** menu, and then press <Enter>.
- 4 Specify the language settings that you want, and then click **Next**.
- 5 Log in as a user who has administrative credentials, and then click **OK**.
- 6 Click **Dell Factory Image Restore**.
- 7 In the **Dell Factory Image Restore** window, click **Next**.

- 8 Select the **Yes, reformat hard drive and restore system software to factory condition** check box.
- 9 Click **Next**. The computer is restored to the default factory configuration.
- 10 When the restore operation is completed, click **Finish** to restart the computer.

## Using the Operating System Media

### Before You Begin

If you are considering reinstalling the Windows operating system to correct a problem with a newly installed driver, first try using Windows Device Driver Rollback (see "Using Windows Device Driver Rollback" on page 144). If Device Driver Rollback does not resolve the problem, then use System Restore to return your operating system to the operating state it was in before you installed the new device driver (see "Using Microsoft Windows System Restore" on page 154).



**NOTICE:** Before performing the installation, back up all data files on your primary hard drive. For conventional hard drive configurations, the primary hard drive is the first drive detected by the computer.

To reinstall Windows, you need the following items:

- Dell *Operating System* media
- Dell *Drivers and Utilities* media



**NOTE:** Your *Drivers and Utilities* media contains drivers that were installed during assembly of the computer. Use your *Drivers and Utilities* media to load any required drivers, including the drivers required if your computer has a RAID controller.

### Reinstalling Windows Vista

The reinstallation process can take 1 to 2 hours to complete. After you reinstall the operating system, you must also reinstall the device drivers, virus protection program, and other software.

 **NOTICE:** The *Operating System* media provides options for reinstalling Windows. The options can overwrite files and possibly affect programs that are installed on your hard drive. Therefore, do not reinstall Windows unless a Dell technical support representative instructs you to do so.

- 1 Save and close any open files and exit any open programs.
- 2 Insert the *Operating System* media.
- 3 Click **Exit** if the **Install Windows** message appears.
- 4 Restart the computer.

When the DELL logo appears, press <F12> immediately.

 **NOTE:** If you wait too long and the operating system logo appears, continue to wait until you see the Microsoft Windows desktop, then shut down your computer and try again.

 **NOTE:** The next steps change the boot sequence for one time only. On the next start-up, the computer boots according to the devices specified in the system setup program.

- 5 When the boot device list appears, highlight **CD/DVD/CD-RW Drive**, and then press <Enter>.
- 6 Press any key to **Boot from CD-ROM**.
- 7 Follow the instructions on the screen to complete the installation.

 **NOTE:** You cannot reinstall Dell MediaDirect if you voluntarily reformat the hard drive. You need the installation software to reinstall Dell MediaDirect. See "Contacting Dell" on page 165.

## Restoring Your Microsoft® Windows® XP Operating System

- System Restore returns your computer to an earlier operating state without affecting data files. Use System Restore as the first solution for restoring your operating system and preserving data files.
- Dell PC Restore by Symantec returns your hard drive to the operating state it was in when you purchased the computer. It permanently deletes all data on the hard drive and removes any programs installed after you received the computer. Use Dell PC Restore only if System Restore did not resolve your operating system problem.

- If you received an *Operating System* disc with your computer, you can use it to restore your operating system. However, using the *Operating System* disc also deletes all data on the hard drive. Use the disc *only* if System Restore did not resolve your operating system problem.

## Using Microsoft Windows System Restore

The Windows operating system provides System Restore to allow you to return your computer to an earlier operating state (without affecting data files) if changes to the hardware, software, or other system settings have left the computer in an undesirable operating state. See the Windows Help and Support Center for information on using System Restore.



**NOTICE:** Make regular backups of your data files. System Restore does not monitor your data files or recover them.



**NOTE:** The procedures in this document were written for the Windows default view, so they may not apply if you set your Dell computer to the Windows Classic view.

### Starting System Restore



**NOTICE:** Before you restore the computer to an earlier operating state, save and close any open files and exit any open programs. Do not alter, open, or delete any files or programs until the system restoration is complete.

- 1 Click **Start**→ **All Programs**→ **Accessories**→ **System Tools**→ **System Restore**.
- 2 Click either **Restore my computer to an earlier time** or **Create a restore point**.
- 3 Click **Next** and follow the remaining prompts on the screen.

In the event that System Restore did not resolve the issue, you may undo the last system restore.

### Undoing the Last System Restore



**NOTICE:** Before you undo the last system restore, save and close all open files and exit any open programs. Do not alter, open, or delete any files or programs until the system restoration is complete.

- 1 Click **Start**→ **All Programs**→ **Accessories**→ **System Tools**→ **System Restore**.
- 2 Click **Undo my last restoration** and click **Next**.

## Enabling System Restore



**NOTE:** If you reinstall Windows XP with less than 200 MB of free hard-disk space available, System Restore is automatically disabled.

To see if System Restore is enabled:

- 1 Click **Start**→ **Control Panel**→ **Performance and Maintenance**→ **System**.
- 2 Click the **System Restore** tab and ensure that **Turn off System Restore** is unchecked.

## Using Dell™ PC Restore



**NOTICE:** Using Dell PC Restore permanently deletes all data on the hard drive and removes any programs or drivers installed after you received your computer. If possible, back up the data before using these options. Use PC Restore only if System Restore did not resolve your operating system problem.



**NOTE:** Dell PC Restore by Symantec may not be available in certain countries or on certain computers.

Use Dell PC Restore only as the last method to restore your operating system. These options restore your hard drive to the operating state it was in when you purchased the computer. Any programs or files added since you received your computer—including data files—are permanently deleted from the hard drive. Data files include documents, spreadsheets, e-mail messages, digital photos, music files, and so on. If possible, back up all data before using PC Restore.

To use PC Restore:

- 1 Turn on the computer.

During the boot process, a blue bar with **www.dell.com** appears at the top of the screen.

- 2 Immediately upon seeing the blue bar, press <Ctrl><F11>.

If you do not press <Ctrl><F11> in time, let the computer finish booting (starting), and then restart the computer again.



**NOTICE:** If you do not want to proceed with PC Restore, click **Reboot**.

- 3 Click **Restore** and click **Confirm**.

The restore process takes approximately 6 to 10 minutes to complete.

- 4 When prompted, click **Finish** to reboot the computer.

 **NOTE:** Do not manually shut down the computer. Click **Finish** and let the computer completely reboot.

- 5 When prompted, click **Yes**.

The computer restarts. Because the computer is restored to its original operating state, the screens that appear, such as the End User License Agreement, are the same ones that appeared the first time the computer was turned on.

- 6 Click **Next**.

The **System Restore** screen appears and the computer restarts.

- 7 After the computer restarts, click **OK**.

To remove PC Restore from the hard drive:

 **NOTICE:** Removing Dell PC Restore from the hard drive permanently deletes the PC Restore utility from your computer. After you have removed Dell PC Restore, you will not be able to use it to restore your computer operating system.

Dell PC Restore enables you to restore your hard drive to the operating state it was in when you purchased your computer. It is recommended that you *do not* remove PC Restore from your computer, even to gain additional hard-drive space. If you remove PC Restore from the hard drive, you cannot ever recall it, and you will never be able to use PC Restore to return your computer operating system to its original state.

- 1 Log on to the computer as a local administrator.
- 2 In Microsoft Windows Explorer, go to `c:\dell\utilities\DSR`.
- 3 Double-click the filename **DSRIRRemv2.exe**.

 **NOTE:** If you do not log on as a local administrator, a message appears stating that you that you must log on as administrator. Click **Quit**, and then log on as a local administrator.

 **NOTE:** If the partition for PC Restore does not exist on your computer hard drive, a message appears stating that the partition was not found. Click **Quit**, because there is no partition to delete.

- 4 Click **OK** to remove the PC Restore partition on the hard drive.
- 5 Click **Yes** when a confirmation message appears.

The PC Restore partition is deleted and the newly available disk space is added to the free space allocation on the hard drive.



- 6 Right-click **Local Disk (C)** in Windows Explorer, click **Properties**, and verify that the additional disk space is available as indicated by the increased value for **Free Space**.
- 7 Click **Finish** to close the **PC Restore Removal** window and restart the computer.

## Using the Operating System Media

### Before You Begin

If you are considering reinstalling the Windows operating system to correct a problem with a newly installed driver, first try using Windows Device Driver Rollback (see "Using Windows Device Driver Rollback" on page 144). If Device Driver Rollback does not resolve the problem, then use System Restore to return your operating system to the operating state it was in before you installed the new device driver (see "Using Microsoft Windows System Restore" on page 154).



**NOTICE:** Before performing the installation, back up all data files on your primary hard drive. For conventional hard drive configurations, the primary hard drive is the first drive detected by the computer.

To reinstall Windows, you need the following items:

- Dell *Operating System* media
- Dell *Drivers and Utilities* media



**NOTE:** Your *Drivers and Utilities* media contains drivers that were installed during assembly of the computer. Use your *Drivers and Utilities* media to load any required drivers, including the drivers required if your computer has a RAID controller.

### Reinstalling Windows XP

The reinstallation process can take 1 to 2 hours to complete. After you reinstall the operating system, you must also reinstall the device drivers, virus protection program, and other software.

 **NOTICE:** The *Operating System* media provides options for reinstalling Windows. The options can overwrite files and possibly affect programs that are installed on your hard drive. Therefore, do not reinstall Windows unless a Dell technical support representative instructs you to do so.

- 1 Save and close any open files and exit any open programs.
- 2 Insert the *Operating System* media.
- 3 Click **Exit** if the **Install Windows** message appears.
- 4 Restart the computer.

When the DELL logo appears, press <F12> immediately.

 **NOTE:** If you wait too long and the operating system logo appears, continue to wait until you see the Microsoft Windows desktop, then shut down your computer and try again.

 **NOTE:** The next steps change the boot sequence for one time only. On the next start-up, the computer boots according to the devices specified in the system setup program.

- 5 When the boot device list appears, highlight **CD/DVD/CD-RW Drive**, and then press <Enter>.
- 6 Press any key to **Boot from CD-ROM**.
- 7 Follow the instructions on the screen to complete the installation.

 **NOTE:** You cannot reinstall Dell MediaDirect if you voluntarily reformat the hard drive. You need the installation software to reinstall Dell MediaDirect. See "Contacting Dell" on page 165.

## Dell™ QuickSet Features



**NOTE:** This feature may not be available on your computer.

Dell™ QuickSet provides you with easy access to configure or view the following types of settings:

- Network connectivity
- Power management
- Display
- System information

Depending on what you want to do in QuickSet, you can start it by either *clicking*, *double-clicking*, or *right-clicking* the QuickSet icon in the Microsoft® Windows® taskbar. The taskbar is located in the lower-right corner of your screen.

For more information about QuickSet, right-click the QuickSet icon and select **Help**.



# Traveling With Your Computer

## Identifying Your Computer

- Attach a name tag or business card to the computer.
- Write down your Service Tag and store it in a safe place away from the computer or carrying case
- Use the Service Tag if you need to report a loss or theft to law enforcement officials and to Dell.
- Create a file on the Microsoft® Windows® desktop called **if\_found**. Place information such as your name, address, and phone number in this file.
- Contact your credit card company and ask if it offers coded identification tags.

## Packing the Computer

- Remove any external devices attached to the computer and store them in a safe place. Remove any cables attached to installed PC Cards, and remove any extended PC Cards. See "Using Cards" on page 69.
- Fully charge the main battery and any spare batteries that you plan to carry with you.
- Shut down the computer.
- Disconnect the AC adapter.
-  **NOTICE:** When the display is closed, extraneous items on the keyboard or palm rest could damage the display.
- Remove any extraneous items, such as paper clips, pens, and paper, from the keyboard and palm rest and close the display.
- Use the optional Dell™ carrying case to pack the computer and its accessories together safely.
- Avoid packing the computer with items such as shaving cream, colognes, perfumes, or food.

- ➔ **NOTICE:** If the computer has been exposed to extreme temperatures, allow it to acclimate to room temperature for 1 hour before turning it on.
- Protect the computer, the batteries, and the hard drive from hazards such as extreme temperatures and overexposure to sunlight, dirt, dust, or liquids.
- Pack the computer so that it does not slide around in the trunk of your car or in an overhead storage compartment.

## Travel Tips

- ➔ **NOTICE:** Do not move the computer while using the optical drive to prevent loss of data.
- ➔ **NOTICE:** Do not check the computer as baggage.
- Consider disabling wireless activity on your computer to maximize battery operating time. To disable wireless activity, press <Fn><F2>.
- Consider changing your power management options (see "Configuring Power Management Settings" on page 58) to maximize battery operating time.
- If you are traveling internationally, carry proof of ownership—or of your right to use the computer if it is company-owned—to speed your passage through customs. Investigate the customs regulations of the countries you plan to visit, and consider acquiring an international carnet (also known as a *merchandise passport*) from your government.
- Find out what type of electrical outlets are used in the countries you will visit, and have appropriate power adapters.
- Check with your credit card company for information about the kinds of emergency travel assistance it offers to users of portable computers.

## Traveling by Air



**NOTICE:** Do not walk the computer through a metal detector. Send the computer through an X-ray machine or have it hand-inspected.

- Ensure that you have a charged battery available in case you are asked to turn on the computer.
- Prior to entering the airplane, verify that using a computer is permitted. Some airlines forbid the use of electronic devices during flight. All airlines forbid the use of electronic devices during takeoff and landing.





## Contacting Dell

 **NOTE:** If you do not have an active Internet connection, you can find contact information on your purchase invoice, packing slip, bill, or Dell product catalog.

Dell provides several online and telephone-based support and service options. Availability varies by country and product, and some services may not be available in your area. To contact Dell for sales, technical support, or customer service issues:

- 1 Visit [support.dell.com](https://support.dell.com).
- 2 Verify your country or region in the **Choose A Country/Region** drop-down menu at the bottom of the page.
- 3 Click **Contact Us** on the left side of the page.
- 4 Select the appropriate service or support link based on your need.
- 5 Choose the method of contacting Dell that is convenient for you.



# Specifications

---

## Processor

---

Processor type	AMD Turion™ 64 or AMD Sempron™
L1 cache	128 KB
L2 cache	256 KB, 512 KB, 1 MB
External bus frequency (front side bus)	533 MHz

---

## System Information

---

System chip set	ATI RS485M / SB600
Data bus width	64 bits
DRAM bus width	dual-channel (2) 64-bit buses
Processor address bus width	40 bits
Flash EPROM	1 MB
Graphics bus	Internal
PCI bus	32 bits

---

## ExpressCard

---

ExpressCard controller	ATI SB600
ExpressCard connector	one ExpressCard slot (54 mm)
Cards supported	ExpressCard/54 (54 mm) 1.5 V and 3.3 V
ExpressCard connector size	26 pins

---

**3-in-1 Media Memory Card Reader**

---

3-in-1 media memory card controller	Ricoh R5C832
3-in-1 media memory card connector	3-in-1 combo card connector
Cards supported	SD/SDIO/MMC
3-in-1 media memory card connector size	30.55 mm x 28.9 mm x 4.55 mm

---

**Memory**

---

Memory module connector	two SODIMM connectors
Memory module capacities	256 MB, 512 MB, 1 GB
Memory type	1.8-V SODIMM DDR-2
Minimum memory	256 MB
Maximum memory	2 GB

---

**Ports and Connectors**

---

Audio	microphone connector, stereo headphone/speakers connector
Mini-Card	one Type IIIA Mini-Card slot
Modem	RJ-11 port
Network adapter	RJ-45 port
USB	four 4-pin USB 2.0-compliant connectors
Video	15-hole connector

---

**Communications**

---

Modem:	
Type	v.92 Data/Fax MDC modem
Controller	softmodem
Interface	HAD Bus
Network adapter	10/100 Ethernet LAN on system board
Wireless	internal PCI-e Mini-Card WLAN

---

**Video**

---

Video type:	integrated on system board
Video controller	ATI R485M
Video memory	up to 128 MB of shared memory (with 256 MB of system memory) or 224 MB of shared memory (with 512 MB of system memory)
LCD interface	LVDS

---

**Audio**

---

Audio type	two-channel high-definition audio codec
Audio controller	Sigmatel STAC9200 Codec
Stereo conversion	24-bit (analog-to-digital and digital-to-analog)
Interfaces:	
Internal	Azalia High Definition Audio
External	microphone-in connector, stereo headphones/speakers connector
Speaker	two 8-ohm speakers
Internal speaker amplifier	1-W channel into 8 ohms
Volume controls	keyboard shortcuts, program menus

---

**Display**

---

Type (active-matrix TFT)	15.4-inch WXGA
Display area (15.4-inch):	
Height	207 mm (8.2 inches)
Width	331.2 mm (13.0 inches)
Diagonal	391.2 mm (15.4 inches)
Maximum resolution	1280 x 800 at 262,144 colors
Refresh rate	60 Hz
Operating angle	0° (closed) to 180°
Viewing angles:	
Horizontal	±40° minimum
Vertical	+10°/-30° minimum
Pixel pitch:	
15.4-inch	0.259 mm
Controls	brightness can be controlled through keyboard shortcuts (see "Display Functions" on page 48)

<b>Keyboard</b>	
Number of keys	87 (U.S. and Canada); 88 (Europe); 91 (Japan)
Layout	QWERTY/AZERTY/Kanji
<b>Touch Pad</b>	
XY position resolution (graphics table mode)	240 cpi
Size:	
Width	73.0-mm (2.9-inch) sensor-active area
Height	42.9-mm (1.7-inch) rectangle
<b>Battery</b>	
Type	9-cell "smart" lithium ion 6-cell "smart" lithium ion 4-cell "smart" lithium ion (when available)
Dimensions:	
Depth	60.1 mm (2.37 inches) (9 cell) 49 mm (1.93 inches) (6 cell) 49 mm (1.93 inches) (4 cell, when available)
Height	24 mm (0.94 inch)
Width	206.8 mm (8.14 inches)
Weight	0.48 kg (1.06 lb) (9 cell) 0.32 kg (0.7 lb) (6 cell) 0.25 kg (0.55 lb) (4 cell, when available)
Voltage	11.1 VDC (6 cell and 9 cell) 14.8 VDC (4 cell, when available)

---

**Battery (continued)**

---

Charge time (approximate):

- Computer off
  - 3.5 hours (9-cell)
  - 2.5 hours (6-cell)
  - 2.5 hours (4-cell, when available)

Operating time

Battery operating time varies depending on operating conditions and can be significantly reduced under certain power-intensive conditions. See "Power Problems" on page 135.

See "Using a Battery" on page 53 for more information on battery life.

Life span (approximate)

300 discharge/charge cycles

Temperature range:

- Operating
  - 0° to 35°C (32° to 95°F)
- Storage
  - 40° to 60°C (-40° to 140°F)

Coin-cell battery

CR-2032

---

**AC Adapter**

---

Input voltage

100–240 VAC

Input current (maximum)

1.5 A

Input frequency

50–60 Hz

Output current

4.34 A (maximum at 4-second pulse);  
3.34 A (continuous)

Output power

65 W

Rated output voltage

19.5 +/-1.0 VDC

Dimensions:

- Height
  - 28.2 mm (1.11 inches)
- Width
  - 57.9 mm (2.28 inches)
- Depth
  - 137.2 mm (5.4 inches)

Weight (with cables)

0.36 kg (0.79 lb)



---

**AC Adapter (continued)**

---

## Temperature range:

Operating	0° to 35°C (32° to 95°F)
Storage	-40° to 65°C (-40° to 149°F)

---

**Physical**

---

Height	36 mm (1.42 inches)
Width	356 mm (14.02 inches)
Depth	265.5 mm (10.45 inches)
Weight (with 6-cell battery):	
Configurable to less than	2.9 kg (6.38 lb)

---

**Environmental**

---

## Temperature range:

Operating	0° to 35°C (32° to 95°F)
Storage	-40° to 65°C (-40° to 149°F)

## Relative humidity (maximum):

Operating	10% to 90% (noncondensing)
Storage	5% to 95% (noncondensing)

## Maximum vibration (using a random-vibration spectrum that simulates user environment):

Operating	0.9 GRMS
Storage	1.3 GRMS

## Maximum shock

**NOTE:** Maximum shock is measured with hard drive in head-parked position and a 2-ms half-sine pulse for operating, and is also measured with hard drive in head-parked position and a 2-ms half-sine pulse for storage.

Operating	122 G
Storage	163 G

---

**Environmental (continued)**

---

Altitude (maximum):

Operating	-15.2 to 3048 m (-50 to 10,000 ft)
Storage	-15.2 to 10,668 m (-50 to 35,000 ft)
Airborne contaminant level	G2 or lower as defined by ISA-S71.04-1985

# Appendix

## Using the System Setup Program



**NOTE:** Your operating system may automatically configure most of the options available in the system setup program, thus overriding options that you set through the system setup program. (An exception is the **External Hot Key** option, which you can disable or enable only through the system setup program.) For more information on configuring features for your operating system, access the Help and Support Center. To access the Help and Support Center in Windows XP, click **Start** → **Help and Support**. In Windows Vista, click the Windows Vista Start button  → **Help and Support**.

You can use the system setup program as follows:

- To set or change user-selectable features—for example, your computer password
- To verify information about the computer's current configuration, such as the amount of system memory

After you set up the computer, run the system setup program to familiarize yourself with your system configuration information and optional settings. You may want to write down the information for future reference.

The system setup screens display the current setup information and settings for your computer, such as:

- System configuration
- Boot order
- Boot (start-up) configuration and docking-device configuration settings
- Basic device-configuration settings
- System security and hard-drive password settings



**NOTE:** Unless you are an expert computer user or are directed to do so by Dell technical support, do not change the system setup settings. Certain changes might make your computer work incorrectly.

## Viewing the System Setup Screens

- 1 Turn on (or restart) your computer.
- 2 When the DELL™ logo appears, press <F2> immediately. If you wait too long and the Microsoft® Windows® logo appears, continue to wait until you see the Windows desktop. Then shut down your computer and try again.

### System Setup Screen



**NOTE:** For information about a specific item on a system setup screen, highlight the item and see the **Help** area on the screen.

On each screen, the system setup options are listed at the left. To the right of each option is the setting or value for that option. You can change settings that appear as white type on the screen. Options or values that you cannot change (because they are determined by the computer) appear less bright.

The upper-right corner of the screen displays help information for the currently highlighted option; the lower-right corner displays information about the computer. System-setup key functions are listed across the bottom of the screen.

---

**Menu bar** — The menu bar lists the major categories of settings available in system setup. Use the right and left arrow keys to move from one menu to another.

---

**Options List** — This field appears on the left side of the system setup window. The field is a scrollable list containing features that define the configuration of your computer.

**Item Specific Help** — This field contains information about each option and the keys to use to change settings.

Scroll up and down the list by using the up and down arrow keys. As an option is highlighted, the

**Item Specific Help**

window displays more information about that option and the option's current and available settings. If the option is configurable, you can press <Enter> to view or change options for that setting.

---

**Key Functions** — This field appears below the **Option Field** and lists keys and their functions within the active system setup field.

---

## Commonly Used Options

Certain options require that you reboot the computer for new settings to take effect.

## Changing the Boot Sequence

The *boot sequence*, or *boot order*, tells the computer where to look to find the software needed to start the operating system. You can control the boot sequence and enable/disable devices using the **Boot Order** page of the system setup program.



**NOTE:** To change the boot sequence on a one-time-only basis, see "Performing a One-Time Boot" on page 179.

The **Boot Order** page displays a general list of the bootable devices that may be installed in your computer, including but not limited to the following:

- Diskette Drive
- Internal HDD
- USB Storage Device
- CD/DVD/CD-RW drive
- Modular bay HDD



**NOTE:** Only devices that are preceded by a number are bootable.

During the boot routine, the computer starts at the top of the list and scans each enabled device for the operating system start-up files. When the computer finds the files, it stops searching and starts the operating system.

To control the boot devices, select (highlight) a device by pressing the down-arrow or up-arrow key, and then enable or disable the device or change its order in the list.

- To enable or disable a device, highlight the item and press the space bar. Enabled items are preceded by a number; disabled items are not preceded by a number.
- To reorder a device in the list, highlight the device and press either <u> to move the device up the list or <d> to move a device down the list.

Boot sequence changes take effect as soon as you save the changes and exit the system setup program.

### ***Performing a One-Time Boot***

You can set a one-time-only boot sequence without entering the system setup program. (You can also use this procedure to boot the Dell Diagnostics on the diagnostics utility partition on your hard drive.)

- 1 Shut down the computer through the **Start** menu.
- 2 Connect the computer to an electrical outlet.
- 3 Turn on the computer. When the DELL logo appears, press <F12> immediately. If you wait too long and the Windows logo appears, continue to wait until you see the Windows desktop. Then shut down your computer and try again.
- 4 When the boot device list appears, highlight the device from which you want to boot and press <Enter>.

The computer boots to the selected device.

The next time you reboot the computer, the previous boot order is restored.

## **Cleaning Your Computer**



**CAUTION:** Before you begin any of the procedures in this section, follow the safety instructions located in the *Product Information Guide*.

### **Computer, Keyboard, and Display**



**CAUTION:** Before you clean your computer, disconnect the computer from the electrical outlet and remove any installed batteries. Clean your computer with a soft cloth dampened with water. Do not use liquid or aerosol cleaners, which may contain flammable substances.

- Use a can of compressed air to remove dust from between the keys on the keyboard and to remove any dirt or lint from the display.
- ➡ **NOTICE:** To help prevent damage to the computer or display, do not spray cleaning solution directly onto the display. Only use products specifically designed for cleaning displays, and follow the instructions that are included with the product.
- Moisten a soft, lint-free cloth with either water or a display cleaner. Do not use alcohol or an ammonia-based cleaner. Wipe the display gently working from the center to the edges until it is clean and any fingerprints are removed. Do not use excessive pressure.

 **NOTICE:** To prevent damage to the antiglare coating, do not wipe the display with soap or alcohol.

- Moisten a soft, lint-free cloth with water and wipe the computer and keyboard. Do not allow water from the cloth to seep between the touch pad and the surrounding palm rest.
- To clean your monitor screen, lightly dampen a soft, clean cloth with water. You can also use a special screen-cleaning tissue or solution suitable for the monitor's antistatic coating.
- Wipe the keyboard, computer, and monitor plastics with a soft cleaning cloth moistened with a solution of three parts water and one part dishwashing detergent.

Do not soak the cloth or let water drip inside your computer or keyboard.

## Touch Pad

- 1 Shut down and turn off your computer. See "Turning Off Your Computer" on page 89.
- 2 Disconnect any attached devices from the computer and from their electrical outlets.
- 3 Remove any installed batteries. See "Using a Battery" on page 53.

Moisten a soft, lint-free cloth with water, and wipe it gently across the surface of the touch pad. Do not allow water from the cloth to seep between the touch pad and the surrounding palm rest.

## Mouse

 **NOTICE:** Disconnect the mouse from the computer before cleaning the mouse.

If your screen cursor skips or moves abnormally, clean the mouse.

### Cleaning a Non-Optical Mouse

- 1 Clean the outside casing of the mouse with a cloth moistened with a mild cleaning solution.
- 2 Turn the retainer ring on the underside of your mouse counterclockwise, and then remove the ball.
- 3 Wipe the ball with a clean, lint-free cloth.



- 4 Blow carefully into the ball cage or use a can of compressed air to dislodge dust and lint.
- 5 If the rollers inside the ball cage are dirty, clean the rollers with a cotton swab moistened lightly with isopropyl alcohol.
- 6 Recenter the rollers in their channels if they are misaligned. Ensure that fluff from the swab is not left on the rollers.
- 7 Replace the ball and retainer ring, and turn the retainer ring clockwise until it clicks into place.

### **Cleaning an Optical Mouse**

Clean the outside casing of the mouse with a cloth moistened with a mild cleaning solution.

### **Floppy Drive**



**NOTICE:** Do not attempt to clean drive heads with a swab. You might accidentally misalign the heads which prevents the drive from operating.

Clean your floppy drive using a commercially available cleaning kit. These kits contain pretreated floppies to remove contaminants that accumulate during normal operation.

### **CDs and DVDs**



**NOTICE:** Always use compressed air to clean the lens in the CD/DVD drive, and follow the instructions that come with the compressed-air product. Never touch the lens in the drive.

If you notice problems, such as skipping, with the playback quality of your CDs or DVDs, try cleaning the discs.

- 1 Hold the disc by its outer edge. You can also touch the inside edge of the center hole.



**NOTICE:** To help prevent damage to the surface, do not wipe in a circular motion around the disc.

- 2 With a soft, lint-free cloth, gently wipe the bottom of the disc (the unlabeled side) in a straight line from the center to the outer edge of the disc.

For stubborn dirt, try using water or a diluted solution of water and mild soap. You can also purchase commercial products that clean discs and provide some protection from dust, fingerprints, and scratches. Cleaning products for CDs are also safe to use on DVDs.

## FCC Notice (U.S. Only)

### FCC Class B

This equipment generates, uses, and can radiate radio frequency energy and, if not installed and used in accordance with the manufacturer's instruction manual, may cause interference with radio and television reception. This equipment has been tested and found to comply with the limits for a Class B digital device pursuant to Part 15 of the FCC Rules.

This device complies with Part 15 of the FCC Rules. Operation is subject to the following two conditions:

- This device may not cause harmful interference.
- This device must accept any interference received, including interference that may cause undesired operation.

 **NOTICE:** The FCC regulations provide that changes or modifications not expressly approved by Dell Inc. could void your authority to operate this equipment.

These limits are designed to provide reasonable protection against harmful interference in a residential installation. However, there is no guarantee that interference will not occur in a particular installation. If this equipment does cause harmful interference with radio or television reception, which can be determined by turning the equipment off and on, you are encouraged to try to correct the interference by one or more of the following measures:

- Reorient the receiving antenna.
- Relocate the system with respect to the receiver.
- Move the system away from the receiver.
- Plug the system into a different outlet so that the system and the receiver are on different branch circuits.

If necessary, consult a representative of Dell Inc. or an experienced radio/television technician for additional suggestions.

The following information is provided on the device or devices covered in this document in compliance with the FCC regulations:

Product name:	Dell™ Vostro™ 1000
Model number:	PP23LB
Company name:	Dell Inc. Worldwide Regulatory Compliance & Environmental Affairs One Dell Way Round Rock, TX 78682 USA 512-338-4400

## **Macrovision Product Notice**

This product incorporates copy protection technology that is protected by U.S. and foreign patents, including patent numbers 5,315,448 and 6,836,549, and other intellectual property rights. The use of Macrovision's copy protection technology in the product must be authorized by Macrovision. Reverse engineering or disassembly is prohibited.



# Glossary

Terms in this Glossary are provided for informational purposes only and may or may not describe features included with your particular computer.

## A

**AC** — alternating current — The form of electricity that powers your computer when you plug the AC adapter power cable in to an electrical outlet.

**ACPI** — advanced configuration and power interface — A power management specification that enables Microsoft® Windows® operating systems to put a computer in standby or hibernate mode to conserve the amount of electrical power allocated to each device attached to the computer.

**AGP** — accelerated graphics port — A dedicated graphics port that allows system memory to be used for video-related tasks. AGP delivers a smooth, true-color video image because of the faster interface between the video circuitry and the computer memory.

**AHCI** — Advanced Host Controller Interface — An interface for a SATA hard drive Host Controller which allows the storage driver to enable technologies such as Native Command Queuing (NCQ) and hot plug.

**ALS** — ambient light sensor — A feature that helps to control display brightness.

**antivirus software** — A program designed to identify, quarantine, and/or delete viruses from your computer.

**ASF** — alert standards format — A standard to define a mechanism for reporting hardware and software alerts to a management console. ASF is designed to be platform- and operating system-independent.

## B

**battery life span** — The length of time (years) during which a portable computer battery is able to be depleted and recharged.

**battery operating time** — The length of time (minutes or hours) that a portable computer battery powers the computer.

**BIOS** — basic input/output system — A program (or utility) that serves as an interface between the computer hardware and the operating system. Unless you understand what effect these settings have on the computer, do not change them. Also referred to as *system setup*.

**bit** — The smallest unit of data interpreted by your computer.

**Blu-ray Disc™ (BD)**— An optical storage technology offering storage capacity of up to 50 GB, full 1080p video resolution (HDTV required), and as many as 7.1 channels of native, uncompressed surround sound.

**Bluetooth® wireless technology** — A wireless technology standard for short-range (9 m [29 feet]) networking devices that allows for enabled devices to automatically recognize each other.

**boot sequence** — Specifies the order of the devices from which the computer attempts to boot.

**bootable media** — A CD, DVD, or floppy disk that you can use to start your computer. In case your hard drive is damaged or your computer has a virus, ensure that you always have a bootable CD, DVD, or floppy disk available. Your *Drivers and Utilities* media is an example of bootable media.

**bps** — bits per second — The standard unit for measuring data transmission speed.

**BTU** — British thermal unit — A measurement of heat output.

**bus** — A communication pathway between the components in your computer.

**bus speed** — The speed, given in MHz, that indicates how fast a bus can transfer information.

**byte** — The basic data unit used by your computer. A byte is usually equal to 8 bits.

## C

**C** — Celsius — A temperature measurement scale where 0° is the freezing point and 100° is the boiling point of water.

**cache** — A special high-speed storage mechanism which can be either a reserved section of main memory or an independent high-speed storage device. The cache enhances the efficiency of many processor operations.

**L1 cache** — Primary cache stored inside the processor.

**L2 cache** — Secondary cache which can either be external to the processor or incorporated into the processor architecture.

**carnet** — An international customs document that facilitates temporary imports into foreign countries. Also known as a *merchandise passport*.

**CD-R** — CD recordable — A recordable version of a CD. Data can be recorded only once onto a CD-R. Once recorded, the data cannot be erased or written over.

**CD-RW** — CD rewritable — A rewritable version of a CD. Data can be written to a CD-RW disc, and then erased and written over (rewritten).

**CD-RW drive** — A drive that can read CDs and write to CD-RW (rewritable CDs) and CD-R (recordable CDs) discs. You can write to CD-RW discs multiple times, but you can write to CD-R discs only once.

**CD-RW/DVD drive** — A drive, sometimes referred to as a combo drive, that can read CDs and DVDs and write to CD-RW (rewritable CDs) and CD-R (recordable CDs) discs. You can write to CD-RW discs multiple times, but you can write to CD-R discs only once.

**clock speed** — The speed, given in MHz, that indicates how fast computer components that are connected to the system bus operate.

**CMOS** — A type of electronic circuit. Computers use a small amount of battery-powered CMOS memory to hold date, time, and system setup options.

**COA** — Certificate of Authenticity — The Windows alpha-numeric code located on a sticker on your computer. Also referred to as the *Product Key* or *Product ID*.

**Consumer IR Port** — A port on the front of the computer that allows certain software applications to be controlled by the Dell Travel Remote in some systems. In other systems, this port allows you to transfer data between the computer and infrared-compatible devices without using a cable connection.

**Control Panel** — A Windows utility that allows you to modify operating system and hardware settings, such as display settings.

**controller** — A chip that controls the transfer of data between the processor and memory or between the processor and devices.

**CRIMM** — continuity rambus in-line memory module — A special module that has no memory chips and is used to fill unused RIMM slots.

**cursor** — The marker on a display or screen that shows where the next keyboard, touch pad, or mouse action will occur. It often is a blinking solid line, an underline character, or a small arrow.

## D

**DDR SDRAM** — double-data-rate SDRAM — A type of SDRAM that doubles the data burst cycle, improving system performance.

**DDR2 SDRAM** — double-data-rate 2 SDRAM — A type of DDR SDRAM that uses a 4-bit prefetch and other architectural changes to boost memory speed to over 400 MHz.

**Dell Travel Remote**— A small remote control stored in the portable computer's ExpressCard slot which provides simple functionality for enjoying multimedia content.

**device driver** — See *driver*.

**DIMM** — dual in-line memory module — A circuit board with memory chips that connects to a memory module on the system board.

**DIN connector** — A round, six-pin connector that conforms to DIN (Deutsche Industrie-Norm) standards; it is typically used to connect PS/2 keyboard or mouse cable connectors.

**disk striping** — A technique for spreading data over multiple disk drives. Disk striping can speed up operations that retrieve data from disk storage. Computers that use disk striping generally allow the user to select the data unit size or stripe width.

**DMA** — direct memory access — A channel that allows certain types of data transfer between RAM and a device to bypass the processor.

**docking device** — provides port replication, cable management, and security features to adapt your notebook to a desktop workspace.

**DMTF** — Distributed Management Task Force — A consortium of hardware and software companies who develop management standards for distributed desktop, network, enterprise, and Internet environments.

**domain** — A group of computers, programs, and devices on a network that are administered as a unit with common rules and procedures for use by a specific group of users. A user logs on to the domain to gain access to the resources.

**DRAM** — dynamic random-access memory — Memory that stores information in integrated circuits containing capacitors.

**driver** — Software that allows the operating system to control a device such as a printer. Many devices do not work properly if the correct driver is not installed in the computer.

**DSL** — Digital Subscriber Line — A technology that provides a constant, high-speed Internet connection through an analog telephone line.

**dual-core** — A technology in which two physical computational units exist inside a single processor package, thereby increasing computing efficiency and multi-tasking ability.

**dual display mode** — A display setting that allows you to use a second monitor as an extension of your display. Also referred to as *extended display mode*.



**DVD-R** — DVD recordable — A recordable version of a DVD. Data can be recorded only once onto a DVD-R. Once recorded, the data cannot be erased or written over.

**DVD+RW** — DVD rewritable — A rewritable version of a DVD. Data can be written to a DVD+RW disc, and then erased and written over (rewritten). (DVD+RW technology is different from DVD-RW technology.)

**DVD+RW drive** — drive that can read DVDs and most CD media and write to DVD+RW (rewritable DVDs) discs.

**DVI** — digital video interface — A standard for digital transmission between a computer and a digital video display.

## E

**ECC** — error checking and correction — A type of memory that includes special circuitry for testing the accuracy of data as it passes in and out of memory.

**ECP** — extended capabilities port — A parallel connector design that provides improved bidirectional data transmission. Similar to EPP, ECP uses direct memory access to transfer data and often improves performance.

**EIDE** — enhanced integrated device electronics — An improved version of the IDE interface for hard drives and CD drives.

**EMI** — electromagnetic interference — Electrical interference caused by electromagnetic radiation.

**ENERGY STAR**<sup>®</sup> — Environmental Protection Agency requirements that decrease the overall consumption of electricity.

**EPP** — enhanced parallel port — A parallel connector design that provides bidirectional data transmission.

**ESD** — electrostatic discharge — A rapid discharge of static electricity. ESD can damage integrated circuits found in computer and communications equipment.

**expansion card** — A circuit board that installs in an expansion slot on the system board in some computers, expanding the capabilities of the computer. Examples include video, modem, and sound cards.

**expansion slot** — A connector on the system board (in some computers) where you insert an expansion card, connecting it to the system bus.

**ExpressCard** — A removable I/O card adhering to the PCMCIA standard. Modems and network adapters are common types of ExpressCards. ExpressCards support both the PCI Express and USB 2.0 standard.

**Express Service Code** — A numeric code located on a sticker on your Dell™ computer. Use the Express Service Code when contacting Dell for assistance. Express Service Code service may not be available in some countries.

**extended display mode** — A display setting that allows you to use a second monitor as an extension of your display. Also referred to as *dual display mode*.

**extended PC Card** — A PC Card that extends beyond the edge of the PC Card slot when installed.

## F

**Fahrenheit** — A temperature measurement scale where 32° is the freezing point and 212° is the boiling point of water.

**FBD** — fully-buffered DIMM — A DIMM with DDR2 DRAM chips and an Advanced Memory Buffer (AMB) that speeds communication between the DDR2 SDRAM chips and the system.

**FCC** — Federal Communications Commission — A U.S. agency responsible for enforcing communications-related regulations that state how much radiation computers and other electronic equipment can emit.

**fingerprint reader** — A strip sensor that uses your unique fingerprint to authenticate your user identity to help secure your computer.

**folder** — A term used to describe space on a disk or drive where files are organized and grouped. Files in a folder can be viewed and ordered in various ways, such as alphabetically, by date, and by size.

**format** — The process that prepares a drive or disk for file storage. When a drive or disk is formatted, the existing information on it is lost.

**FSB** — front side bus — The data path and physical interface between the processor and RAM.

**FTP** — file transfer protocol — A standard Internet protocol used to exchange files between computers connected to the Internet.

## G

**G** — gravity — A measurement of weight and force.

**GB** — gigabyte — A measurement of data storage that equals 1024 MB (1,073,741,824 bytes). When used to refer to hard drive storage, the term is often rounded to 1,000,000,000 bytes.

**GHz** — gigahertz — A measurement of frequency that equals one thousand million Hz, or one thousand MHz. The speeds for computer processors, buses, and interfaces are often measured in GHz.

**graphics mode** — A video mode that can be defined as  $x$  horizontal pixels by  $y$  vertical pixels by  $z$  colors. Graphics modes can display an unlimited variety of shapes and fonts.

**GUI** — graphical user interface — Software that interacts with the user by means of menus, windows, and icons. Most programs that operate on the Windows operating systems are GUIs.

## H

**hard drive** — A drive that reads and writes data on a hard disk. The terms hard drive and hard disk are often used interchangeably.

**heat sink** — A metal plate on some processors that helps dissipate heat.

**hibernate mode** — A power management mode that saves everything in memory to a reserved space on the hard drive and then turns off the computer. When you restart the computer, the memory information that was saved to the hard drive is automatically restored.

**HTTP** — hypertext transfer protocol — A protocol for exchanging files between computers connected to the Internet.

**Hyper-Threading** — Hyper-Threading is an Intel technology that can enhance overall computer performance by allowing one physical processor to function as two logical processors, capable of performing certain tasks simultaneously.

**Hz** — hertz — A unit of frequency measurement that equals 1 cycle per second. Computers and electronic devices are often measured in kilohertz (kHz), megahertz (MHz), gigahertz (GHz), or terahertz (THz).

## I

**iAMT** — Intel® Active Management Technology — Delivers more secure systems management capabilities, regardless of whether the computer is turned on or off, or the operating system is not responding.

**IC** — integrated circuit — A semiconductor wafer, or chip, on which thousands or millions of tiny electronic components are fabricated for use in computer, audio, and video equipment.

**IDE** — integrated device electronics — An interface for mass storage devices in which the controller is integrated into the hard drive or CD drive.

**IEEE 1394** — Institute of Electrical and Electronics Engineers, Inc. — A high-performance serial bus used to connect IEEE 1394-compatible devices, such as digital cameras and DVD players, to the computer.

**infrared sensor** — A port that allows you to transfer data between the computer and infrared-compatible devices without using a cable connection.

**integrated** — Usually refers to components that are physically located on the computer's system board. Also referred to as *built-in*.

**I/O** — input/output — An operation or device that enters and extracts data from your computer. Keyboards and printers are I/O devices.

**I/O address** — An address in RAM that is associated with a specific device (such as a serial connector, parallel connector, or expansion slot) and allows the processor to communicate with that device.

**IrDA** — Infrared Data Association — The organization that creates international standards for infrared communications.

**IRQ** — interrupt request — An electronic pathway assigned to a specific device so that the device can communicate with the processor. Each device connection must be assigned an IRQ. Although two devices can share the same IRQ assignment, you cannot operate both devices simultaneously.

**ISP** — Internet service provider — A company that allows you to access its host server to connect directly to the Internet, send and receive e-mail, and access websites. The ISP typically provides you with a software package, user name, and access phone numbers for a fee.

## K

**Kb** — kilobit — A unit of data that equals 1024 bits. A measurement of the capacity of memory integrated circuits.

**KB** — kilobyte — A unit of data that equals 1024 bytes but is often referred to as 1000 bytes.

**key combination** — A command requiring you to press multiple keys at the same time.

**kHz** — kilohertz — A measurement of frequency that equals 1000 Hz.

## L

**LAN** — local area network — A computer network covering a small area. A LAN usually is confined to a building or a few nearby buildings. A LAN can be connected to another LAN over any distance through telephone lines and radio waves to form a wide area network (WAN).

**LCD** — liquid crystal display — The technology used by portable computer and flat-panel displays.

**LED** — light-emitting diode — An electronic component that emits light to indicate the status of the computer.

**local bus** — A data bus that provides a fast throughput for devices to the processor.

**LPT** — line print terminal — The designation for a parallel connection to a printer or other parallel device.

## M

**Mb** — megabit — A measurement of memory chip capacity that equals 1024 Kb.

**Mbps** — megabits per second — One million bits per second. This measurement is typically used for transmission speeds for networks and modems.

**MB** — megabyte — A measurement of data storage that equals 1,048,576 bytes. 1 MB equals 1024 KB. When used to refer to hard drive storage, the term is often rounded to 1,000,000 bytes.

**MB/sec** — megabytes per second — One million bytes per second. This measurement is typically used for data transfer ratings.

**media bay** — A bay that supports devices such as optical drives, a second battery, or a Dell TravelLite™ module.

**memory** — A temporary data storage area inside your computer. Because the data in memory is not permanent, it is recommended that you frequently save your files while you are working on them, and always save your files before you shut down the computer. Your computer can contain several different forms of memory, such as RAM, ROM, and video memory. Frequently, the word memory is used as a synonym for RAM.

**memory address** — A specific location where data is temporarily stored in RAM.

**memory mapping** — The process by which the computer assigns memory addresses to physical locations at start-up. Devices and software can then identify information that the processor can access.

**memory module** — A small circuit board containing memory chips, which connects to the system board.

**MHz** — megahertz — A measure of frequency that equals 1 million cycles per second. The speeds for computer processors, buses, and interfaces are often measured in MHz.

**Mini PCI** — A standard for integrated peripheral devices with an emphasis on communications such as modems and NICs. A Mini PCI card is a small external card that is functionally equivalent to a standard PCI expansion card.

**Mini-Card** — A small card designed for integrated peripherals, such as communication NICs. The Mini-Card is functionally equivalent to a standard PCI expansion card.

**modem** — A device that allows your computer to communicate with other computers over analog telephone lines. Three types of modems include: external, PC Card, and internal. You typically use your modem to connect to the Internet and exchange e-mail.

**module bay** — See *media bay*.

**MP** — megapixel — A measure of image resolution used for digital cameras.

**ms** — millisecond — A measure of time that equals one thousandth of a second. Access times of storage devices are often measured in ms.

## N

**network adapter** — A chip that provides network capabilities. A computer may include a network adapter on its system board, or it may contain a PC Card with an adapter on it. A network adapter is also referred to as a *NIC* (network interface controller).

**NIC** — See *network adapter*.

**notification area** — The section of the Windows taskbar that contains icons for providing quick access to programs and computer functions, such as the clock, volume control, and print status. Also referred to as *system tray*.

**ns** — nanosecond — A measure of time that equals one billionth of a second.

**NVRAM** — nonvolatile random access memory — A type of memory that stores data when the computer is turned off or loses its external power source. NVRAM is used for maintaining computer configuration information such as date, time, and other system setup options that you can set.

## O

**optical drive** — A drive that uses optical technology to read or write data from CDs, DVDs, or DVD+RWs. Example of optical drives include CD drives, DVD drives, CD-RW drives, and CD-RW/DVD combo drives.

## P

**parallel connector** — An I/O port often used to connect a parallel printer to your computer. Also referred to as an *LPT port*.

**partition** — A physical storage area on a hard drive that is assigned to one or more logical storage areas known as logical drives. Each partition can contain multiple logical drives.

**PC Card** — A removable I/O card adhering to the PCMCIA standard. Modems and network adapters are common types of PC Cards.

**PCI** — peripheral component interconnect — PCI is a local bus that supports 32- and 64-bit data paths, providing a high-speed data path between the processor and devices such as video, drives, and networks.

**PCI Express** — A modification to the PCI interface that boosts the data transfer rate between the processor and the devices attached to it. PCI Express can transfer data at speeds from 250 MB/sec to 4 GB/sec. If the PCI Express chip set and the device are capable of different speeds, they will operate at the slower speed.

**PCMCIA** — Personal Computer Memory Card International Association — The organization that establishes standards for PC Cards.

**PIO** — programmed input/output — A method of transferring data between two devices through the processor as part of the data path.

**pixel** — A single point on a display screen. Pixels are arranged in rows and columns to create an image. A video resolution, such as 800 x 600, is expressed as the number of pixels across by the number of pixels up and down.

**Plug-and-Play** — The ability of the computer to automatically configure devices. Plug and Play provides automatic installation, configuration, and compatibility with existing hardware if the BIOS, operating system, and all devices are Plug and Play compliant.

**POST** — power-on self-test — Diagnostics programs, loaded automatically by the BIOS, that perform basic tests on the major computer components, such as memory, hard drives, and video. If no problems are detected during POST, the computer continues the start-up.

**processor** — A computer chip that interprets and executes program instructions. Sometimes the processor is referred to as the CPU (central processing unit).

**PS/2** — personal system/2 — A type of connector for attaching a PS/2-compatible keyboard, mouse, or keypad.

**PXE** — pre-boot execution environment — A WfM (Wired for Management) standard that allows networked computers that do not have an operating system to be configured and started remotely.

## R

**RAID** — redundant array of independent disks — A method of providing data redundancy. Some common implementations of RAID include RAID 0, RAID 1, RAID 5, RAID 10, and RAID 50.

**RAM** — random-access memory — The primary temporary storage area for program instructions and data. Any information stored in RAM is lost when you shut down your computer.

**readme file** — A text file included with a software package or hardware product. Typically, readme files provide installation information and describe new product enhancements or corrections that have not yet been documented.

**read-only** — Data and/or files you can view but cannot edit or delete. A file can have read-only status if:

- It resides on a physically write-protected floppy disk, CD, or DVD.
- It is located on a network in a directory and the system administrator has assigned rights only to specific individuals.

**refresh rate** — The frequency, measured in Hz, at which your screen's horizontal lines are recharged (sometimes also referred to as its *vertical frequency*). The higher the refresh rate, the less video flicker can be seen by the human eye.

**resolution** — The sharpness and clarity of an image produced by a printer or displayed on a monitor. The higher the resolution, the sharper the image.

**RFI** — radio frequency interference — Interference that is generated at typical radio frequencies, in the range of 10 kHz to 100,000 MHz. Radio frequencies are at the lower end of the electromagnetic frequency spectrum and are more likely to have interference than the higher frequency radiations, such as infrared and light.

**ROM** — read-only memory — Memory that stores data and programs that cannot be deleted or written to by the computer. ROM, unlike RAM, retains its contents after you shut down your computer. Some programs essential to the operation of your computer reside in ROM.

**RPM** — revolutions per minute — The number of rotations that occur per minute. Hard drive speed is often measured in rpm.

**RTC** — real time clock — Battery-powered clock on the system board that keeps the date and time after you shut down the computer.

**RTCST** — real-time clock reset — A jumper on the system board of some computers that can often be used for troubleshooting problems.



## S

**SAS** — serial attached SCSI — A faster, serial version of the SCSI interface (as opposed to the original SCSI parallel architecture).

**SATA** — serial ATA — A faster, serial version of the ATA (IDE) interface.

**ScanDisk** — A Microsoft utility that checks files, folders, and the hard disk's surface for errors. ScanDisk often runs when you restart the computer after it has stopped responding.

**SCSI** — small computer system interface — A high-speed interface used to connect devices to a computer, such as hard drives, CD drives, printers, and scanners. The SCSI can connect many devices using a single controller. Each device is accessed by an individual identification number on the SCSI controller bus.

**SDRAM** — synchronous dynamic random-access memory — A type of DRAM that is synchronized with the optimal clock speed of the processor.

**serial connector** — An I/O port often used to connect devices such as a handheld digital device or digital camera to your computer.

**Service Tag** — A bar code label on your computer that identifies your computer when you access Dell Support at [support.dell.com](http://support.dell.com) or when you call Dell for customer service or technical support.

**setup program** — A program that is used to install and configure hardware and software. The **setup.exe** or **install.exe** program comes with most Windows software packages. *Setup program* differs from *system setup*.

**shortcut** — An icon that provides quick access to frequently used programs, files, folders, and drives. When you place a shortcut on your Windows desktop and double-click the icon, you can open its corresponding folder or file without having to find it first. Shortcut icons do not change the location of files. If you delete a shortcut, the original file is not affected. Also, you can rename a shortcut icon.

**SIM** — Subscriber Identity Module — A SIM card contains a microchip that encrypts voice and data transmissions. SIM cards can be used in phones or portable computers.

**smart card** — A card that is embedded with a processor and a memory chip. Smart cards can be used to authenticate a user on computers equipped for smart cards.

**S/PDIF** — Sony/Philips Digital Interface — An audio transfer file format that allows the transfer of audio from one file to another without converting it to and from an analog format, which could degrade the quality of the file.

**standby mode** — A power management mode that shuts down all unnecessary computer operations to save energy.

**Strike Zone™** — Reinforced area of the platform base that protects the hard drive by acting as a dampening device when a computer experiences resonating shock or is dropped (whether the computer is on or off).

**surge protectors** — Prevent voltage spikes, such as those that may occur during an electrical storm, from entering the computer through the electrical outlet. Surge protectors do not protect against lightning strikes or against brownouts, which occur when the voltage drops more than 20 percent below the normal AC-line voltage level.

Network connections cannot be protected by surge protectors. Always disconnect the network cable from the network connector during electrical storms.

**SVGA** — super-video graphics array — A video standard for video cards and controllers. Typical SVGA resolutions are 800 x 600 and 1024 x 768.

The number of colors and resolution that a program displays depends on the capabilities of the monitor, the video controller and its drivers, and the amount of video memory installed in the computer.

**S-video TV-out** — A connector used to attach a TV or digital audio device to the computer.

**SXGA** — super-extended graphics array — A video standard for video cards and controllers that supports resolutions up to 1280 x 1024.

**SXGA+** — super-extended graphics array plus — A video standard for video cards and controllers that supports resolutions up to 1400 x 1050.

**system board** — The main circuit board in your computer. Also known as the *motherboard*.

**system setup** — A utility that serves as an interface between the computer hardware and the operating system. System setup allows you to configure user-selectable options in the BIOS, such as date and time or system password. Unless you understand what effect the settings have on the computer, do not change the settings for this program.

## T

**TAPI** — telephony application programming interface — Enables Windows programs to operate with a wide variety of telephony devices, including voice, data, fax, and video.

**text editor** — A program used to create and edit files that contain only text; for example, Windows Notepad uses a text editor. Text editors do not usually provide word wrap or formatting functionality (the option to underline, change fonts, and so on).

**TPM** — trusted platform module — A hardware-based security feature that when combined with security software enhances network and computer security by enabling features such as file and e-mail protection.

**travel module** — A plastic device designed to fit inside the module bay of a portable computer to reduce the weight of the computer.

## U

**UAC** — user account control— Microsoft Windows Vista<sup>®</sup> security feature that, when enabled, provides an added layer of security between user accounts and access to operating system settings.

**UMA** — unified memory allocation — System memory dynamically allocated to video.

**UPS** — uninterruptible power supply — A backup power source used when the electrical power fails or drops to an unacceptable voltage level. A UPS keeps a computer running for a limited amount of time when there is no electrical power. UPS systems typically provide surge suppression and may also provide voltage regulation. Small UPS systems provide battery power for a few minutes to enable you to shut down your computer.

**USB** — universal serial bus — A hardware interface for a low-speed device such as a USB-compatible keyboard, mouse, joystick, scanner, set of speakers, printer, broadband devices (DSL and cable modems), imaging devices, or storage devices. Devices are plugged directly in to a 4-pin socket on your computer or in to a multi-port hub that plugs in to your computer. USB devices can be connected and disconnected while the computer is turned on, and they can also be daisy-chained together.

**UTP** — unshielded twisted pair — Describes a type of cable used in most telephone networks and some computer networks. Pairs of unshielded wires are twisted to protect against electromagnetic interference, rather than relying on a metal sheath around each pair of wires to protect against interference.

**UXGA** — ultra extended graphics array — A video standard for video cards and controllers that supports resolutions up to 1600 x 1200.

## V

**video controller** — The circuitry on a video card or on the system board (in computers with an integrated video controller) that provides the video capabilities—in combination with the monitor—for your computer.

**video memory** — Memory that consists of memory chips dedicated to video functions. Video memory is usually faster than system memory. The amount of video memory installed primarily influences the number of colors that a program can display.

**video mode** — A mode that describes how text and graphics are displayed on a monitor. Graphics-based software, such as Windows operating systems, displays in video modes that can be defined as  $x$  horizontal pixels by  $y$  vertical pixels by  $z$  colors. Character-based software, such as text editors, displays in video modes that can be defined as  $x$  columns by  $y$  rows of characters.

**video resolution** — See *resolution*.

**virus** — A program that is designed to inconvenience you or to destroy data stored on your computer. A virus program moves from one computer to another through an infected disk, software downloaded from the Internet, or e-mail attachments. When an infected program starts, its embedded virus also starts.

A common type of virus is a boot virus, which is stored in the boot sectors of a floppy disk. If the floppy disk is left in the drive when the computer is shut down and then turned on, the computer is infected when it reads the boot sectors of the floppy disk expecting to find the operating system. If the computer is infected, the boot virus may replicate itself onto all the floppy disks that are read or written in that computer until the virus is eradicated.

**V** — volt — The measurement of electric potential or electromotive force. One V appears across a resistance of 1 ohm when a current of 1 ampere flows through that resistance.

## W

**W** — watt — The measurement of electrical power. One W is 1 ampere of current flowing at 1 volt.

**WHr** — watt-hour — A unit of measure commonly used to indicate the approximate capacity of a battery. For example, a 66-WHr battery can supply 66 W of power for 1 hour or 33 W for 2 hours.

**wallpaper** — The background pattern or picture on the Windows desktop. Change your wallpaper through the Windows Control Panel. You can also scan in your favorite picture and make it wallpaper.

**WLAN** — wireless local area network. A series of interconnected computers that communicate with each other over the air waves using access points or wireless routers to provide Internet access.

**write-protected** — Files or media that cannot be changed. Use write-protection when you want to protect data from being changed or destroyed. To write-protect a 3.5-inch floppy disk, slide its write-protect tab to the open position.

**WWAN** — wireless wide area network. A wireless high-speed data network using cellular technology and covering a much larger geographic area than WLAN.

**WXGA** — wide-aspect extended graphics array — A video standard for video cards and controllers that supports resolutions up to 1280 x 800.

## **X**

**XGA** — extended graphics array — A video standard for video cards and controllers that supports resolutions up to 1024 x 768.

## **Z**

**ZIF** — zero insertion force — A type of socket or connector that allows a computer chip to be installed or removed with no stress applied to either the chip or its socket.

**Zip** — A popular data compression format. Files that have been compressed with the Zip format are called Zip files and usually have a filename extension of **.zip**. A special kind of zipped file is a self-extracting file, which has a filename extension of **.exe**. You can unzip a self-extracting file by double-clicking it.

**Zip drive** — A high-capacity floppy drive developed by Iomega Corporation that uses 3.5-inch removable disks called Zip disks. Zip disks are slightly larger than regular floppy disks, about twice as thick, and hold up to 100 MB of data.



# Index

## Numbers

3-in-1 media memory card  
reader, 72

## A

audio connectors, 26  
audio. *See sound*

## B

battery  
charge gauge, 29, 55  
charging, 58  
checking the charge, 54  
conserving power, 56  
description, 30  
performance, 53  
power meter, 55  
removing, 59  
replacing coin-cell battery, 106  
storing, 60  
battery-bay latch release, 29  
blanks  
ExpressCards, 69  
removing, 71, 73  
boot sequence, 178  
brightness  
adjusting, 41

## C

CardBus technology  
ExpressCards, 69  
media memory cards, 72  
carnet, 162  
CD  
CD-RW drive problems, 120  
drive problems, 119  
CDs, 63  
about, 63  
operating system, 18  
playing, 61  
Check Disk, 120  
cleaning  
touch pad, 180  
coin-cell battery  
replacing, 106  
computer  
crashes, 131-132  
protecting, 86  
restore to previous operating  
state, 154  
slow performance, 122, 133  
specifications, 167  
stops responding, 131  
connecting  
Mobile Broadband network, 82  
WLAN, 77

contacting Dell, 165

copying CDs  
  general information, 63  
  helpful tips, 65  
  how to, 63

copying DVDs  
  general information, 63  
  helpful tips, 65  
  how to, 63

## D

### Dell

  contacting, 165  
  support site, 16

### Dell Diagnostics

  about, 111  
  starting from the Drivers and  
    Utilities media, 113  
  starting from your hard drive, 111

### Dell MediaDirect

  problems, 132

### Dell Network Assistant, 118

### Dell Support 3, 116

### Dell Support Center, 116

### DellConnect, 118

device status lights, 21

### diagnostics

  Dell, 111

### display

  adjusting brightness, 41  
  description, 21  
  dual display operation, 43  
  primary and secondary, 44  
  removing, 107  
  switching the video image, 41

### display latch, 21

### documentation

  End User License Agreement, 14  
  online, 16  
  Product Information Guide, 14  
  regulatory, 14  
  safety, 14  
  warranty, 14

### drivers

  about, 143  
  identifying, 143  
  reinstalling, 144

### Drivers and Utilities media

  about, 145  
  Dell Diagnostics, 111

### drives

  problems, 119  
  See also *hard drive*  
  See also *optical drive*

### DVD

  drive problems, 119

### DVDs, 63

  about, 63  
  playing, 61



## E

- End User License Agreement, 14
- ergonomics information, 14
- error messages, 123
- ExpressCard slot
  - description, 26
- ExpressCards
  - blanks, 69, 71
  - CardBus technology, 69
  - extended, 69
  - installing, 70
  - Mobile Broadband, 69
  - removing, 71
  - slots, 69
  - types, 69
  - WWAN, 69

## F

- fan
  - description, 25, 30
- Files and Settings Transfer Wizard, 33
- firewall
  - Windows XP, 83
- floppy drive
  - connecting to a USB connector, 26, 28

## H

- hard drive
  - description, 26, 30
  - problems, 120
  - replacing, 92
  - returning to Dell, 94
- hardware
  - Dell Diagnostics, 111
- Hardware Troubleshooter, 147
- Help and Support Center, 17
- help file
  - Windows Help and Support Center, 17
- hibernate mode, 57
- hinge cover
  - removing, 100

## I

- IEEE 1394 connector
  - description, 26
  - problems, 128
- Internet connection
  - about, 31
  - options, 31
  - setting up, 31
- Internet Connection Firewall, 83

## K

- keyboard
  - description, 22
  - numeric keypad, 47
  - problems, 129
  - removing, 101
  - shortcuts, 48
- keyboard status lights
  - description, 23
- keypad
  - numeric, 47

## L

- labels
  - Microsoft Windows, 15
  - Service Tag, 15
- lost computer, 86

## M

- media memory cards
  - blanks, 73
  - CardBus technology, 72
  - installing, 72
  - removing, 73
  - slots, 72
  - types, 72
- memory
  - installing, 95
  - removing, 96

- memory module cover, 30
- messages
  - error, 123
- Microsoft Windows label, 15
- Mini-Card
  - installing, 103
- Mobile Broadband
  - network connections, 82
  - See also *wireless switch*
- Mobile Broadband (WWAN)
  - problems, 134
- modem
  - installing, 98
- modem connector
  - description, 28
- monitor
  - switching the video image, 41
- monitor. See *display*

## N

- network
  - firewall, 83
  - installing WLAN Mini-Card, 103
  - Mobile Broadband (WWAN), 134
  - problems, 134
- network connector
  - description, 28

## O

- operating system
  - CD, 18
  - reinstalling, 18
  - reinstalling Windows Vista, 154
- optical drive
  - description, 25
- optical-drive-tray eject button
  - description, 25

## P

- passwords
  - about, 85
  - forgetting, 86
- PC Restore, 155
- phone numbers, 165
- playing CDs, 61
- playing DVDs, 61
- power
  - hibernate mode, 57
  - line conditioners, 39
  - modes for managing power
    - usage, 55
  - problems, 135
  - protection devices, 39
  - standby mode, 56
  - surge protectors, 39
  - UPS, 39
- power light
  - conditions, 135
- power management
  - conserving battery power, 56
- printer
  - cable, 37
  - connecting, 37
  - problems, 137
  - setting up, 37
  - USB, 37
- problems
  - blue screen, 132
  - CD drive, 119
  - CD-RW drive, 120
  - computer crashes, 131-132
  - computer does not start up, 130
  - computer stops responding, 131
  - Dell Diagnostics, 111
  - Dell MediaDirect, 132
  - drives, 119
  - DVD drive, 119
  - error messages, 123
  - hard drive, 120
  - IEEE 1394 connector, 128
  - keyboard, 129
  - lockups, 130
  - network, 134
  - power, 135
  - power light conditions, 135
  - printer, 137
  - program crashes repeatedly, 131
  - program stops responding, 131
  - programs and Windows
    - compatibility, 131
  - restore computer to previous
    - operating state, 154

- problems (*continued*)
  - restore operating system to previous state, 148, 153
  - scanner, 138
  - slow computer performance, 122, 133
  - software, 130-131, 133
  - sound and speakers, 138
  - speakers, 138
  - spyware, 122, 133
- Product Information Guide, 14
- protecting your computer, 85

## R

- RAM. See *memory*
- regulatory information, 14
- reinstalling
  - Windows Vista, 154

## S

- Safely Remove Hardware
  - icon, 128
- safety instructions, 14
- scanner
  - problems, 138
- screen. See *display*
- security cable slot
  - description, 24
- Service Tag, 15

- software
  - problems, 131, 133
- software and hardware
  - incompatibilities, 147
- sound
  - problems, 138
  - volume, 138
- speakers
  - description, 22
  - problems, 138
  - volume, 138
- specifications, 167
- spyware, 122, 133
- standby mode
  - about, 56
- stolen computer, 86
- support
  - contacting Dell, 165
- support website, 16
- System Restore, 148, 153-154
- system setup
  - screens, 176
- system setup program
  - commonly used options, 177

## T

- taskbar
  - Dell Mobile Broadband Card Utility, 135
  - Safely Remove Hardware, 128

- telephone numbers, 165
- touch pad
  - cleaning, 180
  - customizing, 51
  - description, 22
- tracking software
  - protecting your computer, 86
- transferring information to a new computer, 33
- traveling with the computer
  - by air, 163
  - identification tag, 161
  - packing, 161
  - tips, 162
- troubleshooting
  - Dell Diagnostics, 111
  - Hardware Troubleshooter, 147
  - Help and Support Center, 17
  - restore computer to previous operating state, 148, 153-154

## U

- uninterruptible power supply.  
See *UPS*
- UPS, 39
- USB connectors
  - description, 26, 28

## V

- video
  - problems, 141
- video connector
  - description, 28
- video controller
  - determining configuration, 19
- video controller configuration
  - determining what controller is installed, 19
- volume
  - adjusting, 139

## W

- warranty information, 14
- Windows Vista
  - Device Driver Rollback, 144
  - Program Compatibility wizard, 131
  - reinstalling, 154
  - System Restore, 148, 153-154
- Windows XP
  - Device Driver Rollback, 145
  - Files and Settings Transfer Wizard, 33
  - Help and Support Center, 17
  - hibernate mode, 57
  - Internet Connection Firewall, 83
  - PC Restore, 155
  - reinstalling, 18
  - standby mode, 56

wizards

Files and Settings Transfer

Wizard, 33

Program Compatibility

wizard, 131

WLAN, 75

installing Mini-Card, 103

WWAN. See *Mobile Broadband*